



SUPPLY NETWORK ANALYZER

CVMk-H SERIES

&

CVMk-H-4C SERIES

INSTRUCTION MANUAL

(M 981 322 / 00 B - Manual 1 / 2)

© CIRCUTOR S.A.

CVMk-H-H SUPPLY NETWORK ANALYZER - MANUAL 1 / 2

	page
1.- BASIC INSTRUCTIONS	2
1.1.- Delivery spot check	2
1.2.- Connection procedures	2
2.- MAIN CHARACTERISTICS	3
2.1.- Other characteristics	5
3.- INSTALLATION AND STARTUP	6
3.1.- Installation	6
3.2.- Connection terminal	9
3.3.- Connection drawing for the standard CVMk-H	10
3.4.- Connection drawing for the CVMk-H-ITF	11
4.- OPERATION MODE	15
5.- SETUP	17
5.1.- Phase-Phase or Phase-Neutral Voltage	17
5.2.- Voltage Transformer Primary	18
5.3.- Voltage Transformer Secondary	19
5.4.- Current Transformer Primary	19
5.5.- Parameter SETUP	20
5.6.- First Page SETUP	22
5.7.- Maximum power demand	23
5.8.- TIME / DATE SETUP	24
5.9.- Clearing Energy Counters	25
6.- SPECIFICATIONS	26
7.- SAFETY CONSIDERATIONS	27
8.- MAINTENANCE	27
9.- TECHNICAL SERVICE	28

1.- BASIC INSTRUCTIONS

1.1.- Delivery spot check

This manual is issued to help all the CVMk-H users to install and use it in order get the best from it. After receiving the unit please check the following points:

- (a) Does this device corresponds to your order specifications?
- (b) Check if any damage was done during the shipment process.
- (c) Verify that it includes the following standard accessories:
 - *One connections terminal, *One instruction manual and *One set of labels

1.2.- Connection procedures

Before connecting the instrument to the mains verify the following:

(a) **Power supply : see rear part of your CVMk-H**

- a.1.- **CVMk-H** : Power supply Va.c. (Single phase)
Frequency: 50 ... 60 Hz

Rated voltage:

- 230 V a.c. or 400 V a.c.**
- 240 V a.c. or 480 V a.c.**
- 110 V a.c.**

- a.2.- **CVMk-H.../ SDC** : Power supply Vd.c. (Only available LCD display version)

Rated voltage:

- 24 V d.c.** (20 V d.c. 60 V d.c.)
- 110 V d.c.** (50 V d.c. 150 V d.c.)

- (b) Maximum measuring voltage:

- 500 V a.c. phase-neutral / 866 V a.c. between phases
- A special model for 110 V measuring is available:
100 V a.c. phase-neutral / 173 V a.c. between phases*

- (c) Maximum measuring current: Transformer of In / 5 A a.c.

2.- MAIN CHARACTERISTICS

The CVMk-H power meter is a programmable measuring instrument, offering several operation possibilities selectable in its SETUP option. Before power supplying the instrument, read the **CONNECTIONS** and **SETUP** sections and choose the most suitable operation mode for getting your desired data.

The CVMk-H is an instrument which measures, calculates and displays all the main electrical parameters at any electrical network (balanced or not). The measuring is true RMS value, through three a.c. Voltage inputs and three a.c. Current inputs (from Current Transformers .../ 5A). Besides, the harmonic distortion level (THD) of both current and voltage for each phase is also calculated once per minute.

By means of an internal microprocessor it simultaneously measures:

<i>parameter</i>	<i>L1</i>	<i>L2</i>	<i>L3</i>	<i>Average</i>	<i>Addition</i>
Voltage (phase-neutral)	x	x	x	x	
Voltage (phase-phase)	x	x	x	x	
Current	x	x	x	x	
Active power	x	x	x		x
Reactive power L	x	x	x		x
Reactive power C	x	x	x		x
Power factor	x	x	x	x	
Apparent power					x
Frequency	x				
Voltage THD	x	x	x		
Current THD	x	x	x		

and connecting the Energy + Clock module, besides:

<i>Parameter</i>	<i>CVMk-H</i>	<i>CVMk-H-4C</i>
Date/Time dd/mm/yy hh:mm:ss	TIME	TIME
Active energy (two indep. meters in case of the CVMk-H-4C: demanded energy (+) and generated energy (--))	kWh (+)	kWh (+) and (--)
Reactive energy (inductive), two indep. meters	kvarh.L (+)	kvarh.L (+) and (--)
Reactive energy (capacitive), two indep. meters	kvarh.C (+)	kvarh.C (+) and (--)

The CVMk-H allows reading up to 36 electrical parameters (58 parameters with the expansion modules), shown in 3 big numerical displays, where you can see:

- (a) Phase-phase or phase-neutral voltage of the three phases
- (b) 4 additional visualization screens for 3 parameters to be user-selected (as per attached table).

And also the **MAXIMUM POWER DEMAND**: The power demand is integrated during a prefixed period.

You can select:

- a.- The parameter to be controlled (it can measure active power **kW**, apparent power **kVA** or three phase average current **AIII**).
- b.- the demand period (1 to 60 min.).

This power demand function works with sliding window : shows the accumulated demand over the last period from "now".

** With the optional module CVM / RED-MAX it is also possible to select a power demand function with external synchronism and fixed window.

2.1.- Other Characteristics

- Panel mounting instrument of low dimensions (144 x 144 mm).
- True RMS measurements.
- Memorizes Maximum and Minimum values.
- Autoscaling during data reading.
- **Display : LCD or LEDs**

CVMk-H	Displays of liquid crystal, 4 digits (LCD), dimensions: 67 x 26 mm
CVMk-H-4C (LCD)	Displays of liquid crystal, 5 digits (LCD), dimensions: 67 x 26 mm
CVMk-H (LEDS)	Displays of LEDS , 4 1/2 digits, green colour, dimen.: 60 x 20 mm

- Bubble keyboard, with 4 keys, for control and programming functions.
- 3 x 3 LED indicators (red, green and yellow) to know the parameter shown on display.
- Optional RS232 or RS485 communication modules.



3.- INSTALLATION AND STARTUP

The manual you hold in your hands contains information and warnings that the user should respect in order to guarantee a proper operation of all the instrument functions and keep its safety conditions.

The instrument must not be powered and used until its definitive assembly on the cabinet's door.

Whether the instrument is not used as manufacturer's specifications, the protection of the instrument can be damaged.

When any protection failure is suspected to exist (for example, it presents external visible damages), the instrument must be immediately powered off. In this case contact a qualified service representative.

3.1.- INSTALLATION

Before applying AC power to the, check following points :

a.- **Supply voltage : see rear part of your CVMk-H**
According CVMk-H model:

- a.1.- **CVMk-H** : - Power supply Vac (Single phase) 50 ...60 Hz
- 230 V a.c. or 400 V a.c.**
 - 240 V a.c. or 480 V a.c.**
 - 110 V c.a.**
- *Frequency* : 50 ... 60 Hz
- *Supply tolerance* : + 10 % / --15 %
- *Connection terminals* : *Terminals* 1 - 2 - 3 .
- *Instrument burden* : 3 VA

a.2.- **CVMk-H... / SDC** : - Power supply Vdc (only for LCD display version)

24 V d.c. (20 V d.c. 64 V d.c.)

110 V d.c. (64 V d.c. 130 V d.c.)

- *Connection terminals* : *Terminals 1 - 2 - 3 .*

- *Instrument burden* : *6 VA*

b.- Maximum voltage at the voltage measuring circuit:

Standard : **500 V a.c. phase-neutral / 866 V c.a. between phases**

*A special model CVMk-H-ITF for 110 V measurement is also available:
100 V a.c. phase-neutral / 173 V a.c. between phases*

c.- Maximum admissible current : Transformer of In / 5 A a.c.

d.- Operation conditions :

- Operating temperature : 0 to 50°C

- Humidity : 25 to 80 % R.H. noncondensing

e.- Safety : Designed to meet protection class II as per EN 61010.

Mounting: 

Instrument is to be mounted on panel (cutout $138^{+1} \times 138^{+1}$ mm, as per DIN 43 700). All connections keep inside the cabinet.

Note that with the instrument powered on, the terminals could be dangerous to touching and cover opening actions or elements removal may allow accessing dangerous parts. Therefore, the instrument must not be used until this is completely installed.

The instrument must be connected to a power supply circuit protected with gl type (IEC 269) or M type fuses rated between 0.5 and 2 A. This circuit should be provided with an automatic switch (I / O) or any equivalent element to connect (ON) or disconnect (OFF) the instrument from the power supply network. The supply and measuring voltage circuits will be both connected through a wire with a minimum cross-section of 1 mm^2 .

The line of the current transformer secondary will have a minimum cross-section of $2,5 \text{ mm}^2$.

3.2.- Connection terminal

The CVMk-H has a connection terminal located at the side of the instrument to connect the power supply and the incoming network measuring signals.

This connection terminal consists of: CVMk-H model = 12 terminals
CVMk-H - ITF model = 13 terminals*

Termn. nr.	Parameter
13 *	Neutral
12	VL1
11	VL2
10	VL3
9	S1 IL1
8	S2 IL1
7	S1 IL2
6	S2 IL2
5	S1 IL3
4	S2 IL3
Supply	

CVMk-H....-

A.C. Supply	
3 V
2 V
1	0 V

CVMk-H- / SDC

D.C. Supply	
3	
2	--
1	+d.c.

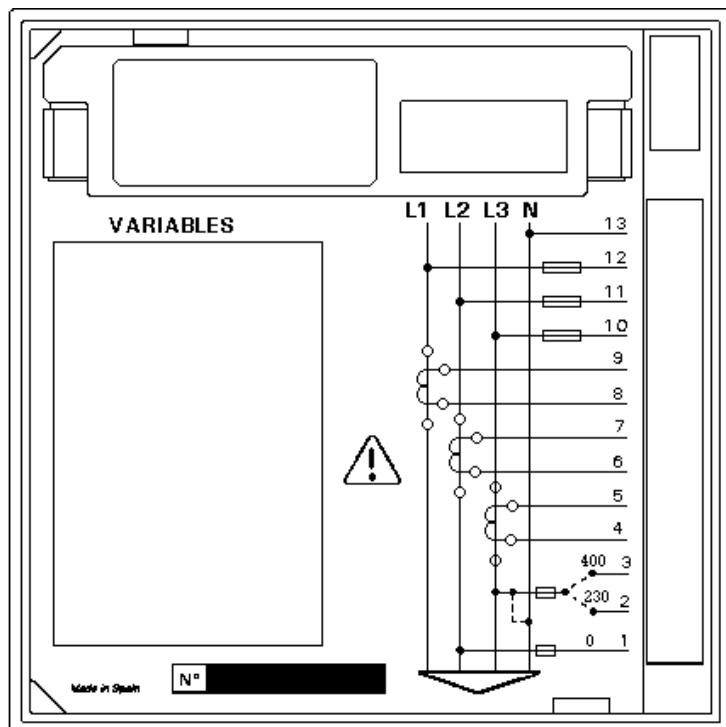

NOTE: Current inputs are isolated in the ... ITF ..1/5 A model

3.3.- Connection drawing for the CVMk-H (12 terminal model - NON ITF)

Connection diagram of the CVMk-H for a low voltage, three phase network.

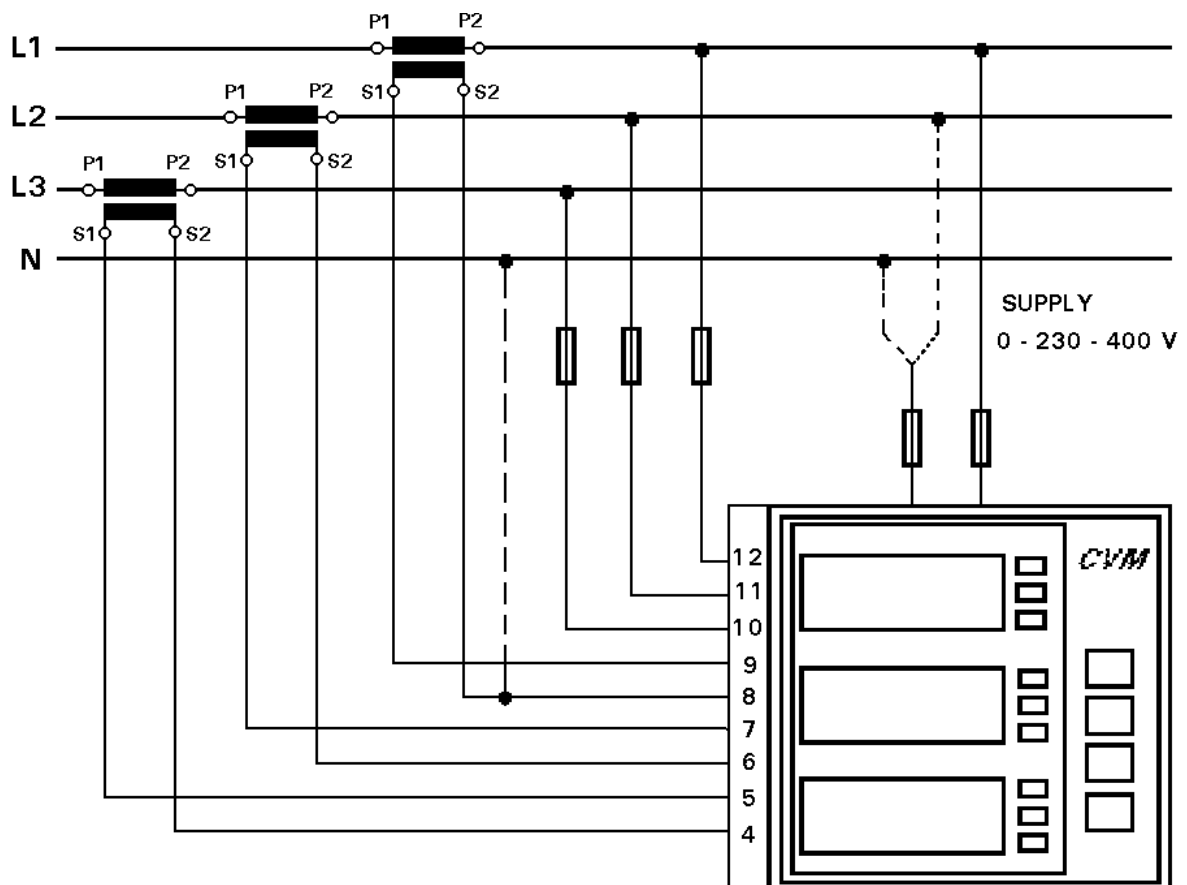

NOTE : FOR A HIGH VOLTAGE NETWORK IS ALWAYS ADVISABLE TO INSTALL THE CVMk-H - ITF... (isolated current inputs).

3.4.- Connection drawing for the CVMk-H - ITF (13 terminal model - ITF)

a) Connection diagram of the CVMk-H-ITF for a low voltage, three phase network:

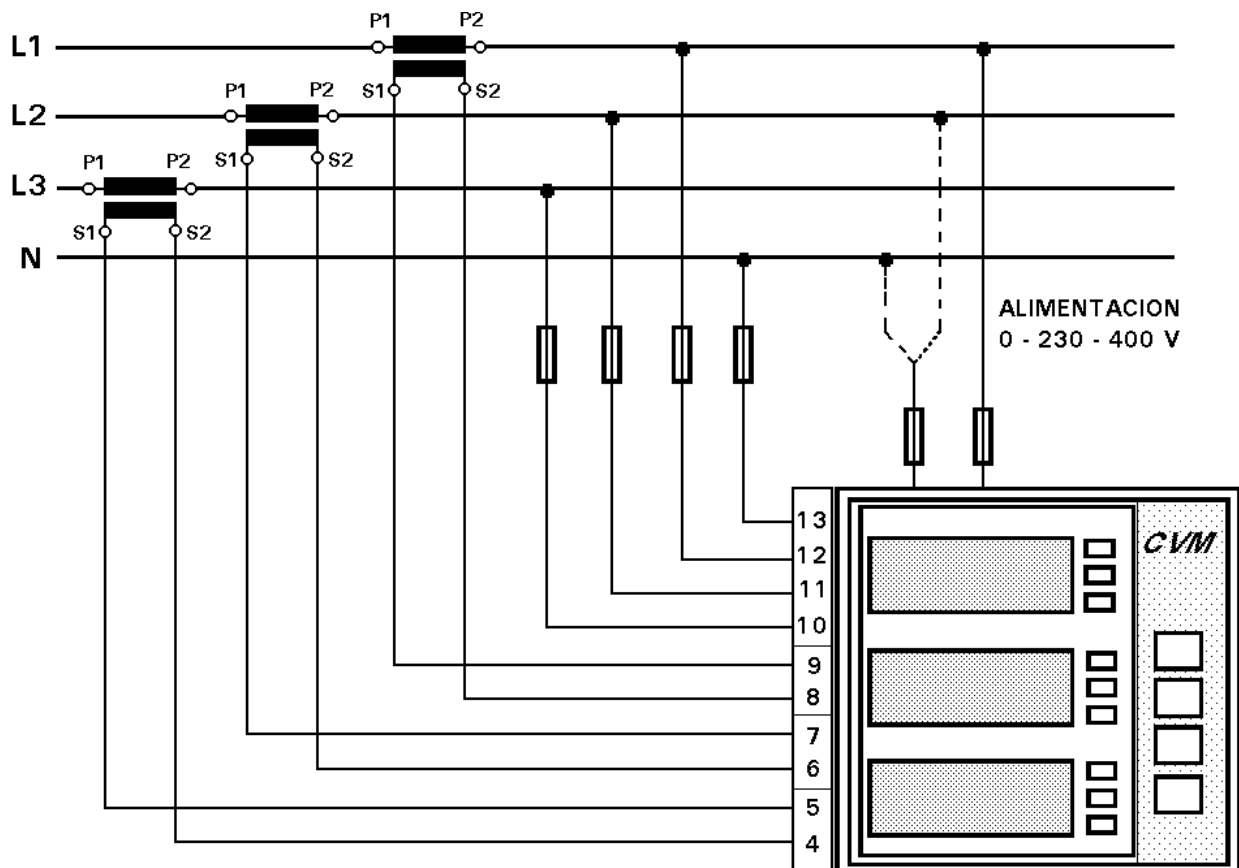

IMPORTANT REMARK! If power = 0 is shown for any of the phases (codes 03, 09 and 15) and voltage and current are not zero for this phase, check out following points:

- Assure that L1, L2 and L3 phases coincide in voltage and current.
- Correct polarity? Reverse the current transformer placed at this phase.

b.- CVMk-H-ITF: 3 current transformers + two voltage transformer :

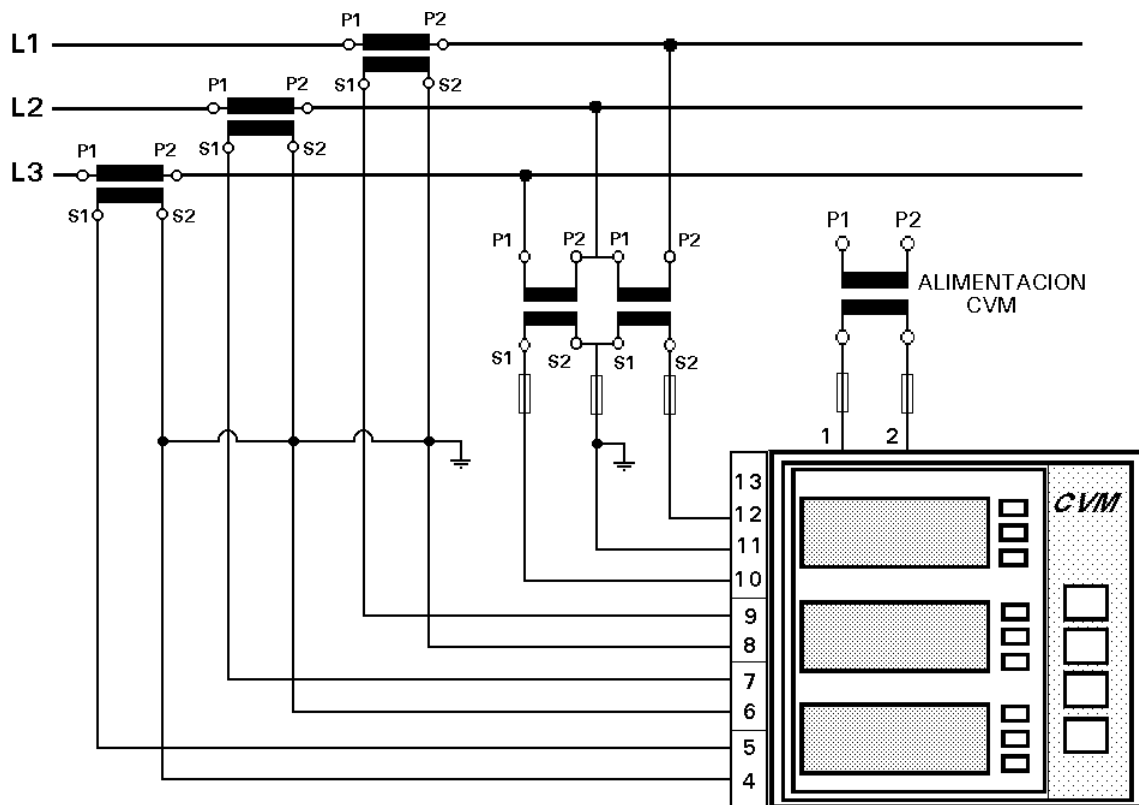

c.- **CVMk-H-ITF** : Two current transformers + 2 voltage transformers.

S2 of the current transformer grounded to earth

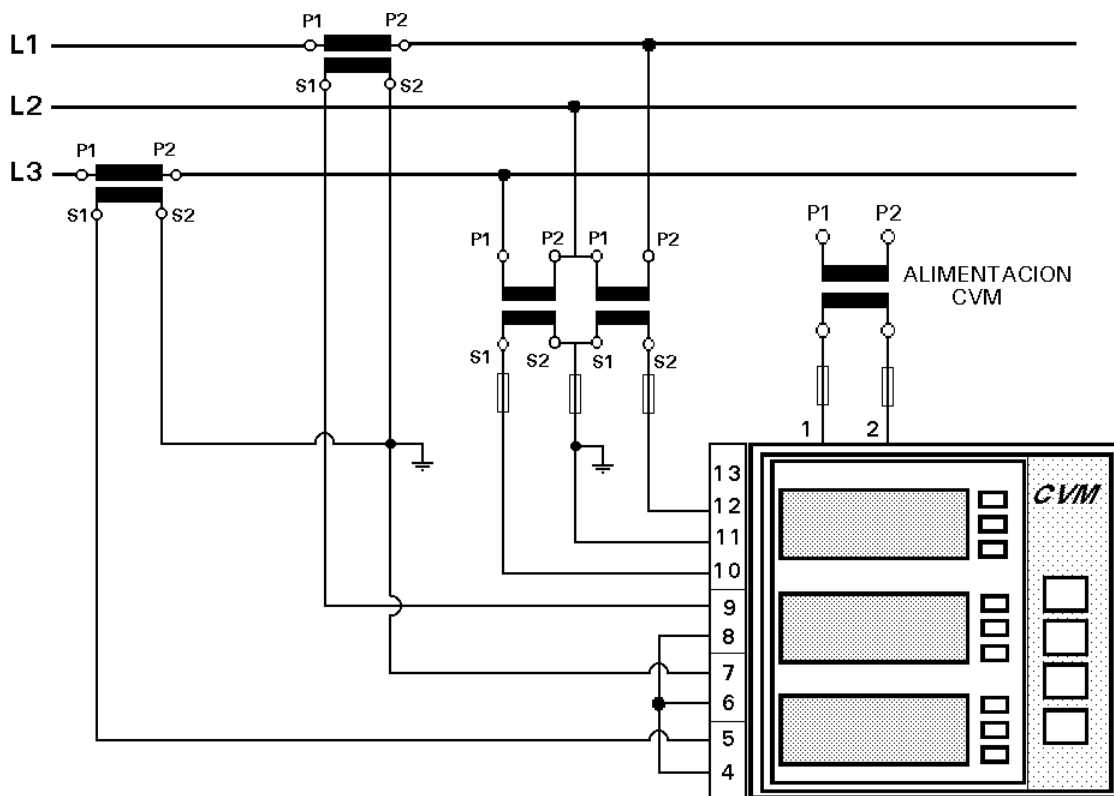

S1 of the current transformer grounded to earth

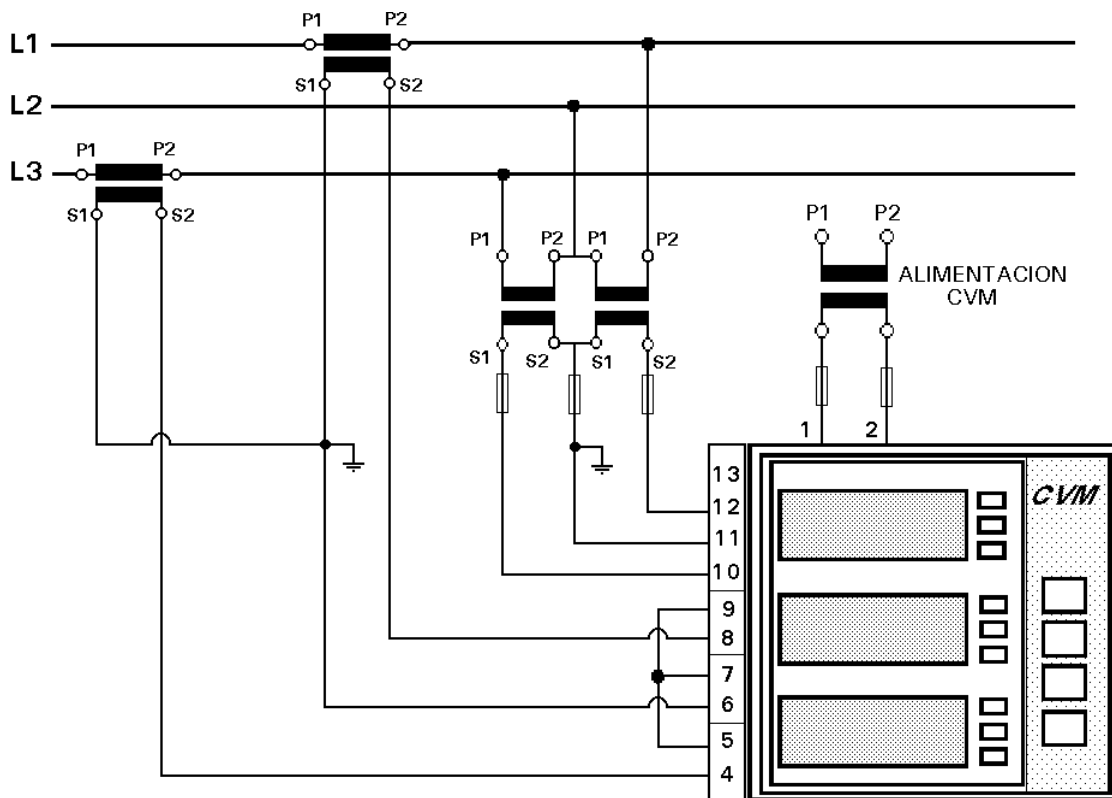

4.- OPERATION MODE

The instrument has three displays, and each one has three LED indicators (red, green and yellow). Every LED indicates the parameter presently shown by display.

When you switch on the power supply of the CVMk-H, all the 9 LED indicators will light on for some seconds, and you will see on the display : "Circutor **xxxx**" (program version) and following you will read "CARD TYPE xxxx" (identification of the connected module). After some seconds the instrument is ready to work, showing one of the three possible screens. One of the leds next to each display lights on indicating the parameter being measured.

display

When the first LED (red) of every display is lighting on, it means that we are reading VOLTAGE values. That is, the first display shows the voltage of phase L1 (V1), the second one the voltage of phase L2 (V2) and third one the voltage of phase L3 (V3).

Leds placed next to each display indicate which parameters are being shown on display. By pressing the key "**display**" diverse visualization screens are accessed, being each screen identified by the lighting leds. The default screen set is shown below, although this configuration can be user-defined in order to show other parameters.

Page	Default values			Leds on
0	V1	V2	V3	Red
1	I1	I2	I3	Green
2	Kw III	PF III	Hz	Yellow
3	Thd V1	Thd V2	Thd V3	Red and Green
4	Thd I1	Thd I2	Thd I3	Red and Yellow

max

Pressing the "**max**" key, the maximum values for the parameters being shown appear in the displays.

This function is only valid while you keep pressing the "**max**" key. If you stop pressing the key the instantaneous values appear again.

When showing maximum values the LED indicators remain blinking.

min

Pressing the "**min**" key, the minimum values for the parameters being shown appear in the displays.

This function is only valid while you keep pressing the "**min**" key. If you stop pressing the key the instantaneous values appear again.

When showing minimum values the LED indicators remain blinking.

Reset

Pressing the "**reset**" key the system is reset. This is equivalent to switch off the power supply of the instrument.

The stored maximum and minimum values will be automatically deleted from the internal memory.

If you are in the setup process and press the "**reset**" key, you exit it without saving any modification that you have done and making a reset of the system.

5.- SETUP

To access into the **setup menu** just follow these steps:

- (a) Connect (supply) the instrument.
- (b) Press the two green buttons (**max**, **min**) simultaneously.

You will see during a few seconds the word "**set**". It means that we are in the setup process. Then we go along the different options, step by step:

5.1.- Phase-Phase or Phase-Neutral voltages

After the word "**set**" you will see on the three displays the voltages of the phases L1, L2, L3.

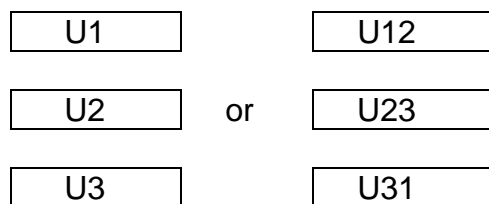

Phase to Neutral Voltages: U1 , U2 , U3

Phase to Phase Voltages : U12 , U23 , U31

a.- To select one of the voltage options just press the green key "**max**" and both options will appear alternately.

b.- When you get in the display the wished option just press the "**display**" key to validate it and access to the next setup option.

5.2.- Voltage Transformer Primary

On the screen we read the word "SET U P" followed by 6 digits. They allow us setting the primary of the voltage transformer.

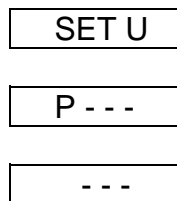

SET U

P - - -

- - -

Last digit of the first display indicates "U" (Voltage) and first digit of the second display indicates "P" (Primary). It means that we can set the primary of the voltage transformer. To avoid mistakes the Voltage red LEDs remain lit on.

a.- To write or modify the value just repeatedly press the "**max**" key and the blinking digit value will be increased.

b.- When the value on screen is the proper one, we can pass to the next digit by pressing the "**min**" key in order to modify the other values.

c.- When the blinking digit is the last one, pressing the "**min**" key we go back to the initial value: set values can be again modified.

d.- Press "**display**" to pass to the next setup option.

5.3.- Voltage Transformer Secondary

We can now set the value of the secondary of the voltage transformer. Only three digits are available:

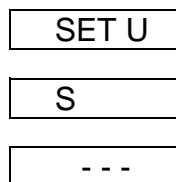

Same process than in point 5.2:

- "**max**" key: Allows us modifying the value of the blinking digit. Each time it is pressed the value is increased.
- "**min**" key: Allows us the validation of the blinking digit and going to the next one.
- Press "**display**" to pass to the next setup option.

If the CVMk-H is directly connected to the mains (without voltage transformer) the values of primary and secondary must be the same, for instance 000001/001.

5.4.- Current Transformer Primary

"SET A P" and five digits appear on screen allowing us to set the primary of the current transformer. The current green LEDs light on to avoid mistakes.

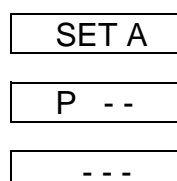

The procedure is the same one done at the previous sections with the "**max**", "**min**" and "**display**" keys.

NOTES:

- The maximum programmable value is 10.000
- The secondary of the current transformers is not programmable. It is automatically taken as 5 A (... / 5 A ac)

5.5.- Parameter SETUP

The 12 additional parameters that we like to see on the screen have to be selected in this option. Each screen is identified by lighting leds according to the following table:

Page	Default values			Leds on
1	I1	I2	I3	Green
2	Kw III	PF III	Hz	Yellow
3	Thd V1	Thd V2	Thd V3	Red and Green
4	Thd I1	Thd I2	Thd I3	Red and Yellow

--

--

--

Each display has two digits to select the desired parameters ,according to the attached code table.

Once the parameters have been programmed we can place the corresponding sticking labels.

Parameter	Symbol phase L1	Code	Symbol phase L2	Code	Symbol phase L3	Code
-----------	--------------------	------	--------------------	------	--------------------	------

Single voltage	V 1	01	V 2	07	V 3	13
Current	A 1	02	A 2	08	A 3	14
Active power	kW 1	03	kW 2	09	kW 3	15
Inductive power	kvarL 1	04	kvarL 2	10	kvarL 3	16
Capacitiva power	kvarC 1	05	kvarC 2	11	kvarC 3	17
Power factor	PF 1	06	PF 2	12	PF 3	18
Voltage THD	THD V1		THD V2		THD V3	
Current THD	THD I 1		THD I 2		THD I3	

Three phase single voltage	Vav III	19	Frequency	Hz	25
Three phase current	Aav III	20	Three ph. apparent power	kVA III	26
Three phase active power	kW III	21	Ph-Ph voltage L1- L2	V 12	27
Three. ph. inductive power.	kvarL III	22	Ph-Ph voltage L2 - L3	V 23	28
Three ph. capacitive power	kvarC III	23	Ph-Ph voltage L3 - L1	V 31	29
Three ph. power factor.	PF III	24	Three ph. Ph-Ph voltage	Vc III	30

By means of the right expansion module also will be available:

Date/ TIME dd/mm/yy hh:mm:ss	TIME	31
---------------------------------	------	----

		tariff 1	tariff 2*	tariff 3*
Active energy	kW.h	32	39	46
Reactive energy (inductive)	kvarh.L	33	40	47
Reactive energy (capacitive)	kvarh.C	34	41	48
Demand power (kW, kVA, AIII)	Pd	35	42	49
Active energy generated	(**) kW.h --	36	43	50
Reactive energy (inductive) gen.	(**) kvarh.L --	37	44	51
Reactive energy (capacitive) gen.	(**) kvarh.C --	38	45	52

(*) To use this option of three billing periods the **CVM/REDMAX** module (by contacts or by set-up) has to be plugged into the CVMk-H.

() only for the CVMk-H of 4 quadrants.**

5.6.- First Page SETUP

This option allows selecting among **fixed or rotary page**:

a.- **Fixed page** (the page is changed pressing the "**display**" key): the page among the five available ones that we want to see when the CVMk-H is supplied (or a reset is made) can be selected.

b.- **Rotary pages**: the page changes to the next one automatically every 5 seconds.

These options are identified with the lighting of the leds:

SET

AUTO

PAGE

- The "**max**" key allows modifying the selected page. The led of the programmed option lights on or all the leds light on in case of the rotary page option.

- The "**display**" key allows the validation of the chosen option.

5.7.- Maximum power demand

Push the key "**display**" and the following screens will appear by display:

- 1.- DEMAND PERIOD (**1 to 60 min.**) ("SET Per xx")
- 2.- PARAMETER TO CONTROL ("SET Pd xx")

Three phase active power	kW III	21
Three phase apparent power	kVA III	26
Three phase average current	AavIII	20

Value of power integrated during the programmed demand period.

- 3.- CLEAR MAXIMUM VALUE IN MEMORY
("CLr Pd xx") **no** or **YES**

PROGRAMMING MODE:

- "**max**" key: allows choosing the different available options.
- "**min**" key: allows the validation of the blinking digit and go forward to the next digit (only for the "SET Per xx" option).
- To pass to the next option press "**display**".

If you don't want to modify anything, just press the "**display**" key three times without modifying any value.

- **Display:** If you program the MAXIMUM POWER DEMAND option, **parameter 35**, the following appears by display (depending on the pressed key):

display	Present value of the demand power meter (Sliding Window , according to the set demand period) updated every second.
max	MAXIMUM integrated value (since last reset)
min	DAY : TIME when this maximum has occurred (only with the CVM/xx - CLOCK module).

OTHER SETUP SCREENS WITH THE CONNECTION OF THE ENERGY AND CLOCK MODULES

5.8.- DATE / TIME SETUP



Pressing the "**display**" key we will see in the CVMk-H.. screen the following:

- 1.- DAY : MONTH ("SET day dd:mm")
- 2.- YEAR ("SET YEAR xxxx ") 4 digits
- 3.- HOURS : MINUTES ("SET HOUR hh:mm")

For their setup:

- "**max**" key: Allows modifying the value of the blinking digit.
- "**min**" key: Allows the validation of the blinking digits and go to the next one.
- To pass to the next option press "**display**".

If you don't want to modify the time, just press three times "**display**" without making any modification.

- **Display**: If you select the parameter 31, following appears by display:

display	HOUR : MINUTES
max	DAY : MONTH
min	MINUTES : SEC.

5.9.- Clearing energy counters

On display we see "CLR ENER no" (Clear energy counters).

- "**max**": To select "YES" or "no"
- "**display**": To validate the selected option. Once finishing this option, all the modifications that we have done are saved in memory and the setup process is finished.

- **Display**: If any of the energies is programmed (kWh, kvarhL or kvarhC), it is displayed as follows:

display	kWh
max	MWh
min	Wh

Example : If the accumulated energy is 32.534,810 kWh, it will be displayed as follows:

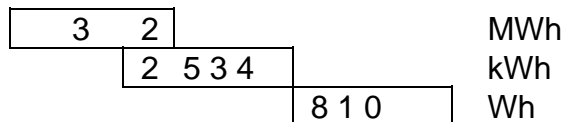

display	2534 kWh
max	32 MWh
min	810 Wh

6.- SPECIFICATIONS

Power supply : see specifications on the rear part of the CVMk-H

- **CVMk-H...** : Single phase 230 V a.c. or 400 V a.c.
240 V a.c. or 480 V a.c.
110 V a.c.

Voltage tolerance: +10 % / -15 %

Frequency: 50 ... 60 Hz

- **CVMk-H... / SDC** : 24 V d.c. or 110 V d.c.

Power consumption 3 VA

Operation temperature 0 to 50° C

Measuring Circuits :

Rated voltage 500 V a.c. Phase - Neutral / 866 V a.c. between phases

Other voltagesWith Voltage Transformers

Rated currentIn / 5 A (**isolated input in the ITF model**)

Permanent overload1.2 In

Current input power0.6 VA

Accuracy :

Voltage 0.5 % of readout ± 2 digits

Current 0.5 % of readout ± 2 digits

Powers 1.0 % of readout ± 2 digits

Test conditions :

- Errors due to Voltage T. and Current T. are not included

- Temperature between + 5 °C and + 45 °C

- Power factor between 0.5 and 1

- Measured values between 5 % ... 100 %

Security Category II , EN-61010

continuous maximum common mode voltage

in current circuit 600 V a.c.

Standards : IEC 664, VDE 0110, UL 94 , IEC 801 , IEC 348 , IEC 571-1
EN 50081-1, EN-61010-1 , EN 50082-1

Mechanical Characteristics :

Installation	Panel mounting
Connection	Fixed connection terminal
Protection	IP-41
Dimensions	144 x 144 mm (DIN 43 700)
Weight	0.75 kg

**7.- SAFETY CONSIDERATIONS**

All installation specification described at the previous chapters named INSTALLATION AND STARTUP, INSTALLATION MODES and SPECIFICATIONS.

Note that with the instrument powered on, the terminals could be dangerous to touching and cover opening actions or elements removal may allow accessing dangerous parts. This instrument is factory-shipped at proper operation condition.

8.- MAINTENANCE

The CVMk-H does not require any special maintenance. No adjustment, maintenance or repairing action should be done over the instrument open and powered and, should those actions are essential, high-qualified operators must perform them.

Before any adjustment, replacement, maintenance or repairing operation is carried out, the instrument must be disconnected from any power supply source.

When any protection failure is suspected to exist, the instrument must be immediately put out of service. The instrument's design allow a quick replacement in case of any failure.

9.- TECHNICAL SERVICE

For any inquiry about the instrument performance or whether any failure happens, contact to CIRCUTOR's technical service.

CIRCUTOR S.A. - Aftersales Service
c / Lepanto , 49
08223 - TERRASSA – SPAIN
Tel - 34 - 3 - 745 29 00
FAX: + 34 - 93 - 745 29 14 / + 34 - 93 - 745 29 13
E_Mail: central@circutor.es

CVMk-H SUPPLY NETWORK ANALYZER - MANUAL 2 / 2

	page
7.- Modules	2
7.1.- Relay output modules	3
7.2.- 4-20 mA output modules	8
8.- CVMk-H COMMUNICATIONS.....	12
8.2.- Demand format	12
8.3.- COMMANDS	13
8.3.1.- Commands for the parameter reading	13
8.3.2.- Programming commands	14
8.3.3.- CVMk-H commands with the ENERGY + Clock module	15
8.3.4.- Maximum power demand commands	16
8.3.5.- Commands to read all the CVMk-H parameters	16
8.3.6.- Commands for the configuration of the relay modules	17
8.3.7.- Commands for the configuration of the 4 - 20 mA modules ..	17
8.4.- Examples	18
8.5.- Configuration	19
9.- APPENDIX	21
9.1.- APPENDIX A : Four quadrants of the CVMk-H- 4C	21
9.2.- APPENDIX B : SECOND SET-UP of the CVMk-H	22
9.3.- APPENDIX C : CVM-RED-C2 module	24
9.4.- APPENDIX D : CVM-RED-420 module	25
9.5.- APPENDIX E : CVM-RED-MAX module	26
9.6.- APPENDIX F : MODBUS ©	30

7.- MODULES :

PCB based modules can be inserted into the rear of the CVMk-H.
The standard modules are:

Code	Type	Description	Version
7 70 190	<i>CVM / ER</i>	Energy Module	card 6
7 70 191	<i>CVM / 485</i>	RS-485 Module	card 3
7 70 192	<i>CVM / 232</i>	RS-232 Module	card 0
7 70 193	<i>CVM / ER-485</i>	RS-485 + energy Module	card 5
7 70 194	<i>CVM / ER-232</i>	RS-232 + energy Module	card 4
7 70 195	<i>CVM / RED</i>	Energy + COM1, RS485 + COM2, RS-485 for peripherals	card 1
7 70 196	<i>CVM / ER420-1</i>	Energy + 1 4 -20 mA output	card 211
7 70 197	<i>CVM / ER420-2</i>	Energy + 2 4 -20 mA output	card 212
7 70 198	<i>CVM / ERC-1</i>	Energy + 1 output relay	card 201
7 70 199	<i>CVM / ERC-2</i>	Energy + 2 output relays	card 202
7 70 200	<i>CVM / ERC-420-1</i>	Energy + 1 output relay + 1 4 -20 mA output	card 221
7 70 205	<i>CVM / RED- MAX</i>	RED + 3 inputs (synchronism + tariff type)	card 231
7 70 206	<i>CVM / RED- 420-1</i>	RED + 1 4 -20 mA output	card 251
7 70 207	<i>CVM / RED- C2</i>	RED + 2 outputs	card 242

Expansion modules provide more parameters to be displayed (additional SETUP).

ADDITIONAL SCREEN WITH THE RELAY OUTPUT MODULES

7.1.- Relay modules: **CVM-ERC-1** (1 relay), **CVM-ERC-2** (2 relays),
CVM-ERC420-1 (1 relay + 1 analog output) or the **CVM-RED-C2** (2 outputs).

With this modules the CVMk-H - can be configured for:

A.- **Pulse every certain kW.h or kvar.h (ENERGY).** You can define the value corresponding to the energy consumed for generating a pulse (0.5 sec. long): kW.h / 1 pulse or kvar.h / 1 pulse

B.- **ALARM conditions:** the parameter to be controlled, the maximum value, the minimum value and the "delay" are programmed for each relay output.

On the CVMk-H screen following messages appear at this SET-UP point (provided the right module is connected to the equipment):

OUT 1	RELAY 1
CODE	
00	 Parameter Nr. (1)

 *Depending on the selected variable we will pass to a.- or b.- sections*

In case that no parameter is wanted to be programmed set *par. Nr. = 00.*

a.- If an ENERGY parameter is chosen: 32, 33 or 34

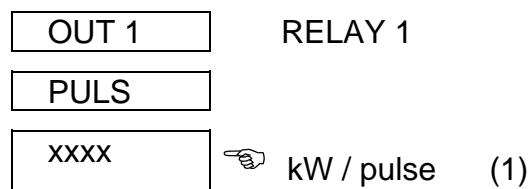

(1) Value of energy in kW : four digits with floating decimal point

- For programming:

- "**max**" key: it allows modifying the value of the blinking value.
Every time it is pressed the number is increased.
- "**min**" key: it allows validating the blinking value and go to the next digit.

NOTE : When you arrive at the last digit, you can move the position of the decimal point with the "**max**" key.

Example for programming a 500 W / 1 pulse:

Firstly we enter the value, 0500, and following we place the decimal point at the right position with the "**max**" key → 0.500 kW.

- For passing to the next option, press "**display**": setup options for the second relay will appear (only with the modules type **CVM-ERC-2** or **CVM-RED-C2**).

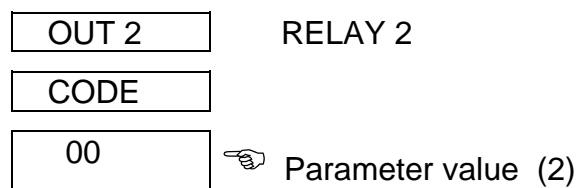

Act as before. Pressing again "**display**" key you exit setup mode.

b.- **ALARM conditions** (1 condition for each relay): If any other parameter (from 1 to 30 or from 54 to 59) is selected in (1), two outputs can be configured as alarms. For each output it is possible to program:

①	Any of the parameters measured by the CVMk-H
②	MAXIMUM value
③	MINIMUM value
④	Delay for the conditions

These screens are successively displayed by the CVMk-H once the parameter has been selected (for the setup of each option proceed as in the Section a.-):

b.1.- Programming the maximum value to be controlled:

OUT 1	RELAY 1
AL HI	
0.000	 Maximum value

b.2.- Programming the minimum value to be controlled:

OUT 1	RELAY 1
AL LO	
0.000	 Minimum value

b.3.- Programming the delay:

OUT 1	RELAY 1
SEC	Delay in seconds
0.000	 maximum 9999 sec.

- Press "**display**" to pass to the next option: the setup for the second relay appears (only with modules type **CVM-ERC-2** or **CVM-RED-C2**).

OUT 2	RELAY 2
CODE	
00	☞ Parameter Nr. (1)

Proceed as before. Pressing again "**display**" we exit the setup option.

ALARM ACTIVATION: The alarms depend on the programmed values of MAXIMUM and MINIMUM.

MIN +	MAX + max > min	ON OFF ON _____ _____}=====1_____
		0 Min Max
MIN +	MAX + max < min	OFF ON OFF =====1_____ =====
		0 Max Min
MIN --	MAX +	ON OFF ON _____}==== ====1_____
		Min 0 Max
MIN +	MAX --	OFF ON OFF =====1_____ =====
		Max 0 Min
MIN --	MAX -- max > min	ON OFF ON _____}=====1_____ _____
		Min Max 0
MIN --	MAX -- max < min	OFF ON OFF =====1_____}==== =====
		Max Min 0

ON = alarm activated -----> relay closed
 OFF = alarm deactivated -----> relay open

The **DELAY** set value is applied either to the connection or the disconnection when the alarm conditions occur.

The programming units for the different parameters are:

Parameter	Format	Example
Voltage	Without decimals = V (xxx)	0220 = 220 V
	With decimals = k (xxx.x)	125.0 = 125 kV
		25.30 = 25.30 kV
Current	A	0150 = 150 A
Powers	kW, kvar, kVA	0.540 = 540 W
		250.5 = 250.5 kW
Energies	kW.h, kvar.h	
Power factor	x.xx	- 0.7 = - 0.70
Frequency	xx.x	50.0 = 50 Hz
THD	xx.x	10.0=10%



Connections of the module DB-9 connector : CVM-ERC-2 (2 relays)

	Terminals	Signal		Terminals	Signal
RELAY 1	6	Common relay 1	RELAY 2	9	Common relay 2
	2	N.O.		5	N.O.
	1	N.C.		4	N.C.

- Maximum voltage between terminals = 100 V a.c.

- For the **CVM-ERC-1 and CVM-ERC420-1** modules connect according to the specified for the RELAY 1.

**** For the CVM-RED-C2 module (Communication + 2 static outputs) see its corresponding annex.**

ADDITIONAL SCREEN WITH THE 4 - 20 mA OUTPUT MODULES

7.2.- 4 - 20 mA output modules: *CVM/ER420-1* (1 analog output), *CVM/ER420-2* (2 analog outputs), *CVM/ERC 420-1* (1 relay +1 analog output), *CVM/RED-420* (communications + 1 4 -20 mA output).

With this module we can configure the CVMk-H - to give an output of **4 - 20 mA d.c. or of 0 - 20 mA d.c. (resolution of 4.000 points)** proportional to any of the parameters measured by the CVMk-H, **with the ability of setting the scale (offset and full scale).**

On the CVMk-H screen following messages appear at this SET-UP point (provided the right module is connected to the equipment):

a.- Parameter choosing:

dA 1	OUTPUT D/A Nr.1
Code	
XX	 Parameter Nr.

- "**max**" -- "**min**" keys: allow the selection of any parameter from 01 to 30
- "**display**" key: validates the selected option and passes to the next setup screen.

b.- Election of 0 - 20 mA or 4 - 20 mA :

dA 1	OUTPUT D/A Nr.1
Scal	Scale :
4 - 20	 allows choosing a 0 - 20 mA or 4 - 20 output (" max " or " min " key)

- "**display**": to validate the selected option and pass to the next setup screen.

c.- Scale offset:

Value of the parameter that we assign as the zero of the scale.

dA 1	OUTPUT D/A Nr.1
Zero	zero of the scale:
x.XXX	 allows choosing the zero of the scale (four digits with floating decimal point)

- "**max**" key: it allows modifying the value of the blinking value.
Every time it is pressed the number is increased.

- "**min**" key: it allows validating the blinking value and go to the next digit.

NOTE : When you arrive at the last digit, you can move the position of the decimal point with the "**max**" key.

- "**display**": to validate the selected option and pass to the next setup screen.

d.- Full scale: Value of the parameter to which we assign the 20 mA.

dA 1	OUTPUT D/A Nr.1
F.ESC	Full scale:
x.XXX	 allows choosing the full scale (20 mA) (four digits with floating decimal point)

Proceed as in the previous section.

- For passing to the next option, press "**display**": the setup for the second output will appear (only with a module type CVM/ER420-2).

dA 2	OUTPUT D/A Nr.2
code	
xxxx	

Proceed as in the previous sections.

1.- Connections of the module DB-9 connector : CVM/ER 420-2

	Terminals	Signal
Channel 1	1 - 2	make a bridge
	7	20 mA (+) (Common)
	6	20 mA (-)

	Terminals	Signal
Channel 2	4 - 5	make a bridge
	8	20 mA (+) (Common)
	9	20 mA (-)

- For the **CVM/ER 420-1** module connect according to Channel 1.
- For the **CVM/ERC 420-1** module connect according to Channel 2.

**** For the CVM-RED420 module (Communications + 1 4- 20 mA output) see its corresponding annex.**

2.- Output calculation:

Resolution = $\frac{20 - \text{Zero}}{\text{F. scale} - \text{offset}}$	Offset & f. scale = defined by the user Zero = 0 mA or 4 mA
mA = ((F. scale - offset) x Resolution) + Zero	
mV = mA x ohms	mV (100 ohms) = mA x 100

- Maximum load is of 250 Ω (5 V - 20 mA)
- The maximum allowed offset is a value equal to the 90% of the full scale.



Output of the power factor parameter (P.F.):

0/4 mA -----	-----20 mA
+0.00 Ind. 1.00	Cap. - 0.00

3.- Default full scale:

<i>Parameter</i>	<i>Condition</i>	<i>Full scale (20 mA)</i>
Voltages (V)	Primary < 500	Primary x 500 /secondary
	Primary > 500	Voltage primary
Currents (A)		Current primary
Powers (kW)	For one phase	voltage primary x current primary / 1000
	Three phase value	voltage primary x current primary x 3 / 1000
Frequency (Hz)		65
P.F.		- 0.00

4.- Connections to directly have a voltage output: 0 - 2 V c.c.

Connections of the module DB-9 connector:

	Terminals	Signal
Channel 1	6 - 7	make a bridge
	1	(+)
	2	(-) common

	Terminals	Signal
Channel 2	8 - 9	make a bridge
	5	(+)
	4	(-) common

8. CVMk-H COMMUNICATIONS

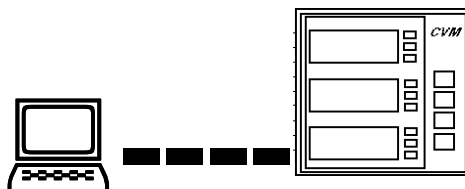

One or some CVMk-H... can be connected to a computer. With this system we can get all the parameters in one central point of reading. The CVMk-H..., with the CVM/xx485 module, has a serial output type RS-485. If we connect more than one CVMk-H... to the same communication line, we have to assign to each of them a different code or direction (from 01 to 99), since the computer needs the identification of every measuring point. The CVMk-H... can also work with a serial output type RS-232, with the use of a CVM/xx232 module.

PROTOCOL: Question / Answer

8.2.- DEMAND FORMAT

The demand format is: **\$PPCCAA.... ch [LF]** (example = **\$00RVI75**)

The answer format is : **\$PPAA.... ch [LF]**

\$	Any message starts with this symbol
PP	CVMk-H code or direction (00 a 99) (decimal- ASCII)
CCC	COMMAND
AA	ARGUMENT: Only with the writing commands Wxx (decimal-ASCII)
Ch	CHECK-SUM : Check-sum of all the elements forming the message. It is calculated with the decimal addition of all the previous bytes in ASCII and translating the result to hexadecimal. Two digits are taken. <u>example</u> = \$00RVI --> 36 + 48 + 48 + 82 + 86 + 73 = 373 373 decimal \equiv 175 hexad. CHECK-SUM = 75 ----> \$00RVI75 [LF]
[LF]	LINE FEED indicates the end of the message. (chr\$(10))

8.3.- COMMANDS

8.3.1.- COMMANDS FOR THE PARAMETER READING

COM-MAND	CONCEPT	QUESTION	ANSWER	UNITS
RVI	Read V ph.-neutral INST	\$ PP RVI ch	\$ PP 4 x 9 digits ch	V
RVM	Read V ph.-neutral MAX	\$ PP RVM ch	\$ PP 3 x 9 digits ch	V
RVm	Read V ph.-neutral MIN	\$ PP RVm ch	\$ PP 3 x 9 digits ch	V
ROI	Read V phase-ph. INST	\$ PP ROI ch	\$ PP 4 x 9 digits ch	V
ROM	Read V.phase-ph. MAX	\$ PP ROM ch	\$ PP 3 x 9 digits ch	V
ROm	Read V.phase-ph. MIN	\$ PP ROm ch	\$ PP 3 x 9 digits ch	V
RAI	Read Current INST	\$ PP RAI ch	\$ PP 4 x 9 digits ch	mA
RAM	Read Current MAX	\$ PP RAM ch	\$ PP 3 x 9 digits ch	mA
RAm	Read Current MIN	\$ PP RAm ch	\$ PP 3 x 9 digits ch	mA
RPI	Read Active power INST	\$ PP RPI ch	\$ PP 4 x 9 digits ch	W
RPM	Read Active power MAX	\$ PP RPM ch	\$ PP 4 x 9 digits ch	W
RPm	Read Active power MIN	\$ PP RPm ch	\$ PP 4 x 9 digits ch	W
RLI	Read Induc. pow. INST	\$ PP RLI ch	\$ PP 4 x 9 digits ch	var.L
RLM	Read Induc. pow. MAX	\$ PP RLM ch	\$ PP 4 x 9 digits ch	var.L
RLm	Read Induc. pow. MIN	\$ PP RLm ch	\$ PP 4 x 9 digits ch	var.L
RCI	Read Capac. pow. INST	\$ PP RCI ch	\$ PP 4 x 9 digits ch	var.C
RCM	Read Capac. pow. MAX	\$ PP RCM ch	\$ PP 3 x 9 digits ch	var.C
RCm	Read Capac. pow. MIN	\$ PP RCm ch	\$ PP 3 x 9 digits ch	var.C
RFI	Read P.F. INST	\$ PP RFI ch	\$ PP 4 x 9 digits ch	x 100
RFM	Read P.F. MAX	\$ PP RFM ch	\$ PP 3 x 9 digits ch	x 100
RFm	Read P.F. MIN	\$ PP RFm ch	\$ PP 3 x 3 digits ch	x 100
RHI	Read Frequency INST	\$ PP RHI ch	\$ PP 1x 3 digits ch	Hz x 10
RHM	Read Frequency MAX	\$ PP RHM ch	\$ PP 1x 3 digits ch	Hz x 10
RHm	Read Frequency MIN	\$ PP RHm ch	\$ PP 1x 3 digits ch	Hz x 10
RQI	Read Apparent pow. INST	\$ PP RQI ch	\$ PP 1 x 9 digits ch	VA
RQM	Read Apparent pow. MAX	\$ PP RQM ch	\$ PP 1 x 9 digits ch	VA
RQm	Read Apparent pow. MIN	\$ PP RQm ch	\$ PP 1 x 9 digits ch	VA
RTH	Values of INST.THLD	\$ PP RTH ch	\$ pp 6 x 9 digits ch	% x 10
RTM	Values of MAX.THLD	\$ PP RTM ch	\$ pp 6 x 9 digits ch	% x 10
RTm	Values of MIN.THLD	\$ PP RTm ch	\$ pp 6 x 9 digits ch	% x 10

Note: 3x9 digits Voltage THD + 3x9 digits Current THD

8.3.2.- PROGRAMMING COMMANDS

COM-MAND	CONCEPT	QUESTION	ANSWER
RRT	Read transforming ratios (prim V, sec V, prim A)	\$pp RRT ch	\$pp 14 digits ch (6 + 3 + 5)
WRT	Write transforming ratios	\$pp 14 digits ch (6 + 3 + 5)	\$PP ACK ch
RRS	Read communications (*)	\$pp RRS ch	\$pp 13 digits ch
WRS	Write communications (*)	\$pp 13 digits ch	\$PP ACK ch
RCP	Read configuration Page 2 + Page3 + initial page	\$pp RCP ch	\$pp 13 digits ch (6 x 2 + 1 initial)
WCP	Write configuration. Page	\$pp 13 digits ch	\$PP ACK ch
RMM	Read type of set voltage (single / compound)	\$pp RMM ch	\$PP 1 digit ch 1=S / 0 =C
WMM	Write measuring mode (single / compound)	\$pp 1 digit ch 1=single / 0 = comp	\$PP ACK ch
VER	Read CVMk-H version	\$pp VER ch	\$PP 4 digits ch
TAR	Read type of card (module) + scale kW- MW (Lo - Hi)	\$pp TAR ch	\$PP 5 digits ch (4 card + 1 scale)
DEF	Write default parameters	\$pp DEF ch	\$PP ACK ch
INI	Reset	\$pp INI ch	-----

(*) NOTE : The RRS / WRS command (communications):

- 2 digits peripheral number / 1 digit Parity / 1 digit length / 1 digit Stop bits/
4 digits Baud rate SERIAL output / 4 digit Baud rate 2nd output (only for "RED"
module: 2nd RS-485 output).

8.3.3.- CVMk-H-... COMMANDS WITH THE ENERGY + CLOCK MODULE

(* negative energies only for the CVMk-H- 4C (four quadrants).

COM..	CONCEPT	QUESTION	ANSWER	UNIT
RWH (*)	Read active energy (positive, negative - absolute value -)	\$pp RWH ch	\$pp 1 x 9 digits ch \$pp 2 x 9 digits ch	W.h
RLH (*)	Read inductive energy (positive, negative - absolute value -)	\$pp RLH ch	\$pp 1 x 9 digits ch - For the CVMk-H-4C : \$pp 2 x 9 digits ch	varh.L
RCH (*)	Read capacitive energy (positive, negative - absolute value)	\$pp RCH ch	\$pp 1 x 9 digits ch - For the CVMk-H-4C : \$pp 2 x 9 digits ch	varh.C
RCE	Read initial value of the positive energies: kW.h, Kvarh.L and kvarh.C	\$pp RCE ch	\$pp 3 x 9 digits ch	W.h
(*) RCe	Read initial value of the negative energies: kW.h, kvarh.L and kvarh.C	\$pp RCe ch	\$pp 3 x 9 digits ch	W.h
WCE	Write the three positive energies (write initial value).	\$pp 3 x 9 digits ch	\$pp ACK ch	W.h
(*) WCe	Write the absolute value of the three negative energies (write initial value).	\$pp 3 x 9 digits ch	\$pp ACK ch	W.h
RCL	Read date and time dd/mm/yy hh:mm:ss	\$pp RCL ch	\$pp 17 characters ch	
WCL	Write value for the clock dd/mm/yyyy hh:mm:ss	\$pp 19 charac. ch (10 + space +8)	\$pp ACK ch	
RTS	Read SET-UP of three billing period operation mode (CVM/ RED-MAX module)	\$pp RTS ch	\$pp 3 digits ch arg: 1d. tariff/ clock +1 Syncro/clock +1active tariff type	

8.3.4.- MAXIMUM POWER DEMAND COMMANDS

COM.	CONCEPT	QUESTION	ANSWER
RPE	Read power demand period + param. (kW=21, KVA=26 or AIII=20)	\$pp RPE ch	\$pp 2 x 2 digits ch
WPE	Write power demand period (2 dig.) + param. (kW=21, kVA=26, AIII=20)	\$pp WPEXXXch	\$pp ACK ch
CMD	Delete maximum demand value pd=0	\$pp CMD ch	\$pp ACK ch
RMD	Read maximum demand value: DATE, MAXIMUM (from the last reset), LAST PERIOD MAXIMUM	\$pp RMD ch	\$pp 35 digits ch xx/xx/xx xx:xx:xx xxxxxxxxxx (9 dig) xxxxxxxxxx (9 dig)

8.3.5.- COMMAND to read all the CVMk-H parameters

COMMAND	CONCEPT	QUESTION	ANSWER SIZE
RAL	Read TOTAL	\$pp RAL ch	\$pp + 244 bytes + ch

With this parameter all the parameters are requested: 30 x 8 bytes in hexa-ASCII format in the following order:

[0] L12	[1] L23	[2] L31	[3] Av	Voltage phase-phase
[4] L1	[5] L2	[6] L3	[7] Av	Voltage phase-neutral
[8] L1	[9] L2	[10] L3	[11] Av	Current
[12] L1	[13] L2	[14] L3	[15] III	Active power
[16] L1	[17] L2	[18] L3	[19] III	Inductive power
[20] L1	[21] L2	[22] L3	[23] III	Capacitive power
[24] L1	[25] L2	[26] L3	[27] Av	Power factor
			[28]	Frequency
			[29] III	Apparent power

- 2 bytes : current units 00 - mA / 01 - A
- 2 bytes : power units 00 - W / 01 - kW

(*) - Power factor (x 100) : When is capacitive it adds 200

0 ----- 100 ----- 200
+0.0 Ind. 1.0 Cap. -0.00

8.3.6.- COMMANDS FOR THE CONFIGURATION OF THE RELAY MODULES

COM.	CONCEPT	QUESTION		ANSWER
RCC	Read configuration (W.h or kvar.h)	\$pp RCC ch	\$pp 22 digits ch arg : code channel 1 param. (2 dig) + value1 (9 dig)+code channel 2 param.+value2 (9 dig)	
WCC	Write module configuration (W.h or kvar.h)	\$pp WCC13 digits ch argument : channel number (2 dig) + parameter code (2 dig) + value (9 dig)		\$pp ACK ch

ALARM CONFIGURATION : parameter + maximum + minimum + delay

RCA	Read alarm configuration 2 relays	\$pp RCA ch	\$pp 2 x 25 digits ch argument: parameter 1 code (2 dig) + maximum value 1 (9 dig) +minimum value 1 (9 dig) + delay (4 dig) + relay status (1 dig)	
WCA	Write module configuration	\$pp WCA 26 digits ch argument: channel number (2 dig) + parameter code (2 dig)+maximum value (9 dig) +mín v. (9 dig.) + delay (4 dig)		\$pp ACK ch

8.3.7.- COMMANDS FOR THE CONFIGURATION OF THE 4 - 20 mA MODULES

COM.	CONCEPT	QUESTION		ANSWER
RDA	Read configuration	\$pp RDA ch	\$pp 2 x 13 digits ch argument: mode 0-20 mA/ 4 - 20 mA (2 dig) +parameter code (2 dig) + offset value (9 dig)	
RFE	Read full scale	\$pp RFE ch	\$pp 9 digits channel 1 + 9 dig. channel 2 ch	
WDA	Write module configuration	\$pp WDA 24 digits ch argument: channel number (2 dig) + mode 0-20 mA/ 4 - 20 mA (2 dig) + parameter code (2 dig) + offset value (9 dig) + full scale (9 dig.)		\$pp ACK ch

8.4.- EXAMPLES

<p>SEND : \$00RFI65 [LF] (Power factor) RECEIVED : \$00083083084083F1[LF]</p> <p>(\$00, PF1= 083 , PF2= 083 , PF3= 084 = 0.84 ind , Pavg = 0.83)</p>
<p>SEND : \$00RVI75 [LF] RECEIVED : \$00000000219000001210000010300000014865 [LF]</p> <p>\$00, V1 = 000000219 = 219 V V2 = 000000121 = 121 V V3 = 000000103 = 103 V Vavg = 000000148 = 148 V</p>
<p>SEND : \$00RRT7C [LF] (V / A ratio) RECEIVED : \$000250001100050032 [LF]</p> <p>\$00, Voltage primary = 025000 = 25.000 (6 digits). Voltage secondary = 110 = 110 (3 digits). Current primary = 00500 = 500 (5 digits).</p>
<p>SEND : \$00RRS7B [LF] (Communication) RECEIVED: \$00000719600480017 [LF]</p> <p>\$00, Peripheral number = 00 Parity = 0 = Non (1 dig.) Bits = 7 (1 dig.) Stop bits = 1 (1 dig.) Baud rate = 9600 (4 dig.) (COM1) 2^a Baud rate = 4800 (4 dig.) (COM2 - RED module)</p>
<p>SEND : \$00RAI60 [LF] RECEIVED : \$0000021400000019000000018500000019600073 [LF]</p> <p>\$00, A1= 000214000 = 214000 mA = 214 A A2= 000190000 = 190000 mA = 190 A A3= 000185000 = 185000 mA = 185 A Am =000196000 = 196000 mA = 196 A</p>

8.5.- DEFAULT CVMk-H CONFIGURATION : 00 / 9.600 / 7 bits / N / 1 bit

- Available baud rates: 2.400 - 4.800 - 9.600 - 19.200 bauds

- **CVM / RS-485 module: DB-9 - Male connector**

Nr. pin	Signal
1 ①	----- TX --
2 ②	----- TX +
5 ⑤	----- GND

- **CVM/ RS-232 module: RS-232 cable (CVMk-H ----- PC - DB-9)**

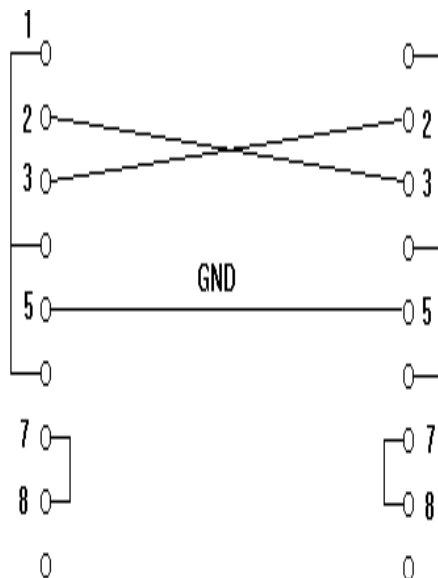

- RS-485 COMMUNICATION LINK TO MULTIPLE DEVICES

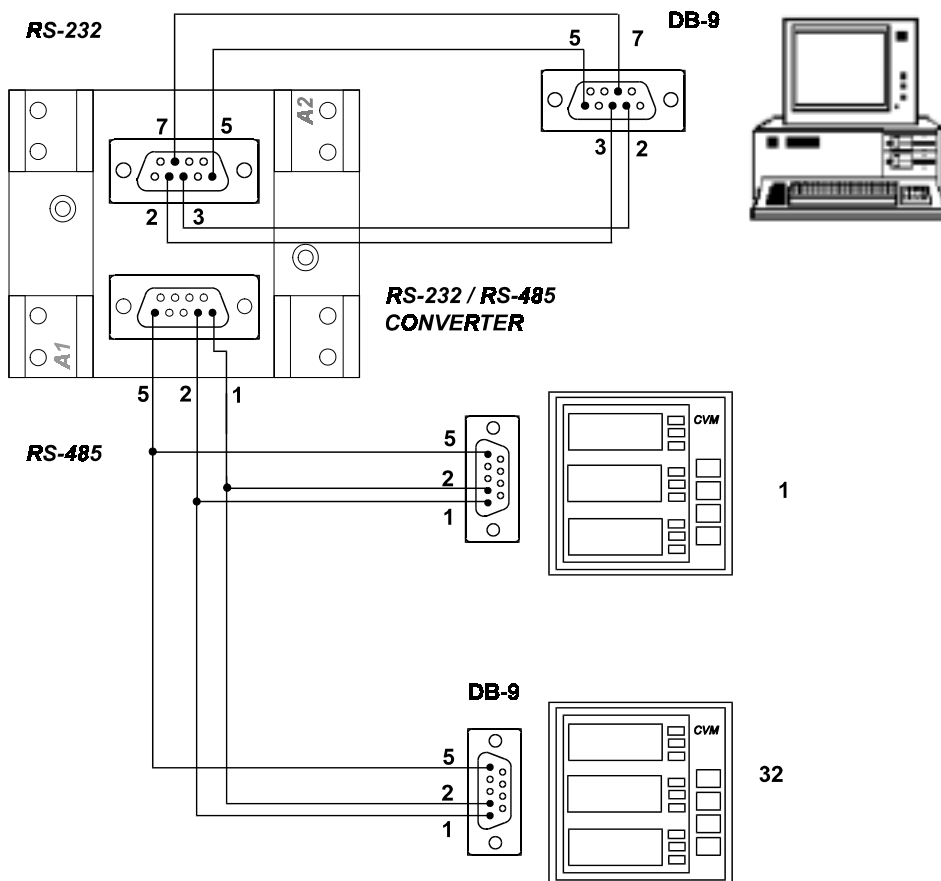

☑ RS-485 connection will be carried out by means of a **twisted and screened cable**, with a minimum of 3 wires, with a maximum distance between the CVMk-H and the last peripheral of 1.200 m. The CVMk-H with the CVM/xxx485 module uses a RS-485 communication bus allowing up to a **maximum of 32 devices in parallel (Multidot bus) per used port of the PC.**

9.1.- APPENDIX A: FOUR QUADRANTS OF THE CVMk-H-4C-

Example of the phase difference between voltage and current	Active power kW or kW.h	Reactive power kvar or kvar.h	P.F.
30°	kW +	kvar L +	+
300°	kW +	kvar C +	--
210°	kW --	kvar L --	+
120°	kW --	kvar C --	--

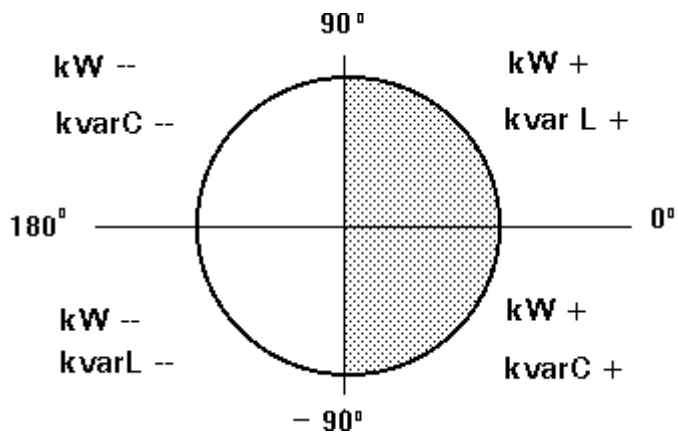

9.2.- APPENDIX B: Second SET-UP of the CVMk-H

It is possible to access to a second MENU of SET-UP that allows the configuration of the CVMk-H with other options different of the standard ones.

To enter into it proceed as follows:

- Without power supply in the CVMk-H, press simultaneously "**display**", "**max**" and "**min**" keys.
- Keeping these keys pressed, supply the CVMk-H.

We will read on the CVMk-H screen the following:

1.- COMMUNICATION PROTOCOL SETUP mode

SET	
PROT	Protocol:
CIRC	 CIRCUTOR (CIRC) or MODBUS (c) (BUS) protocol

The "**max**" key allows the modification of this option.
(*) To work with MODBUS see the **APPENDIX F**

- "**display**" key: allows validating the selected option and pass to the next setup screen:

2.- Power units setup

SET	
ESCA	power scale:
LO	 Selection of kW (LO) or MW (HI)

The "**max**" key allows the modification of this option
If MW is chosen, all the powers and energies are measured in "Megas".

- "**display**" key: allows validating the selected option and passing to the next setup screen:

3.- Communication parameters setup

SET

Cdef

default configuration

NO



"**max**" key allows choosing NO / YES

- If YES is chosen: the configuration is **00 / 9.600 / 7 bits / N / 1 bit**
- If NO is chosen, pressing "**display**" following options successively appear:
 - n PER : Peripheral Nr.
 - Baud 1 : baud rate
 - Parity : No, even, odd
 - LEN : (length) 7 or 8
 - Stop bits : 1 or 2
 - Baud 2 : com2 ("NETWORK") baud rate - peripherals connection

9.3.- APPENDIX C : CVM-RED-C2 module (Communications + 2 static outputs)

This module is equal to the CVM/RED module, with the addition of two outputs of free voltage contacts (Card type 0242).

- **DB- 9 OUTPUT:** it corresponds to a CVM/RED module.
This module provides:

- a.- ENERGY (kW.h , kvarh.L and kvarh.C)
- b.- Main serial communication RS-485

1 ① ----- TX --
2 ② ----- TX +
5 ⑤ ----- GND

c.- 2nd. RS-485 serial output for the link to the peripherals: 3, 4 & 5 pins

3 ③ ----- TX --
4 ④ ----- TX +
5 ⑤ ----- GND

**- CONNECTION TERMINAL OF COMBICON type (4 terminals):
2 static output module**

- Static type contacts by OPTOMOS element (120 mA - 300 V peak).

①	Output 1
②	
③	Output 2
④	

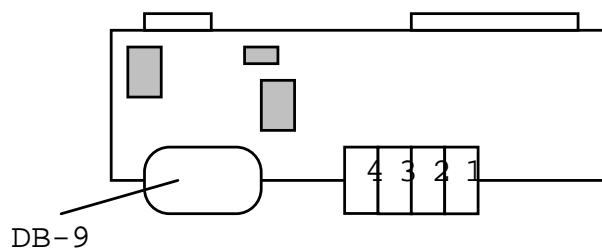

9.4.- APPENDIX D : CVM-RED-420 module

This module is equal to the CVM/RED, with the addition of a 4 - 20 mA analog output. (Card type 0251)

- **DB- 9 OUTPUT:** it corresponds to a CVM/RED module.
This module provides:

- a.- ENERGY (kW.h , kvarh.L and kvarh.C)
- b.- Main serial communication RS-485

1 ① ----- TX --
2 ② ----- TX +
5 ⑤ ----- GND

c.- 2nd. RS-485 serial output for the link to the peripherals: 3, 4 & 5 pins

3 ③ ----- TX --
4 ④ ----- TX +
5 ⑤ ----- GND

- CONNECTION TERMINAL OF COMBICON type (4 terminals): 1 4 - 20 mA output module

- Supply: An **external supply** between 8 and 15 Vdc is required
- The maximum load that can be connected to the output depends on the supply voltage: $R_{max} = (V_{supp} (min) - 5) / 0.02$

①	-- V supply
②	-- 0 / 20 mA
③	+ 0 / 20 mA
④	+ V supply

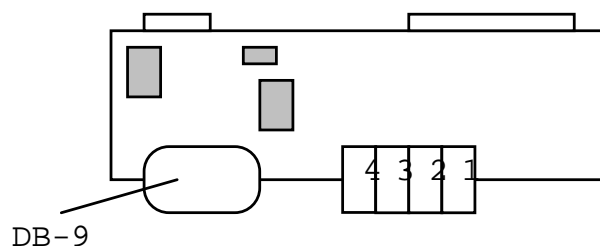

9.5.- APPENDIX E : CVM-RED-MAX module

With this module (Card type 0231) **THREE billing periods can be controlled**, each one with a meter of kW.h, kvarh.L, kvarh.C and maximum power demand: The CVMk-H has then a total of 9 METERS (18 meters for the four quadrants CVMk-H-4C).

There are two ways for the change of the billing periods (tariffs):

a.- By HARDWARE:

It has three free voltage inputs (12 Vd.c. - 8 mA maximum).

- Two outputs for the selection of the tariff type which the CVMk-H is working with (**TARIFF 1, TARIFF 2 or TARIFF 3**).

- One input for the synchronism with the utility demand period.

- CONNECTION TERMINAL OF COMBICON type (4 terminals):

①	Tariff 2 (bridge between ①-④)
②	Tariff 3 (bridge between ②-④)
③	Synchronism with demand controller clock
④	Common

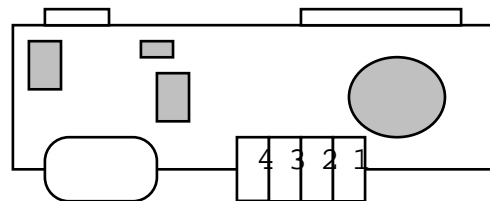

b.- By SOFTWARE : The type of tariff can be also selected by programming the CVMk-H through its serial port by means of a PC (see manual of CVM_ST software). The tariffs fixed for each billing period are programmed for every day.

Two additional screens appear in the CVMk-H when this module is connected:

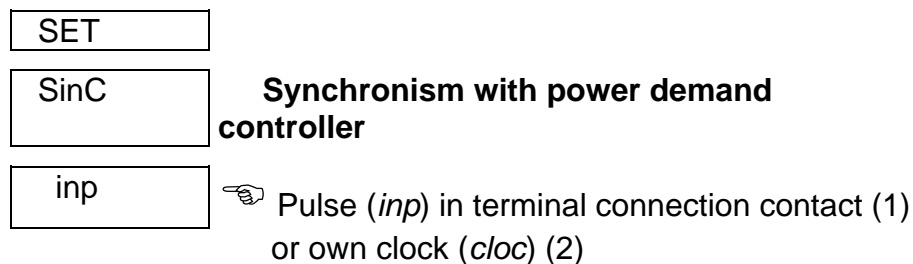
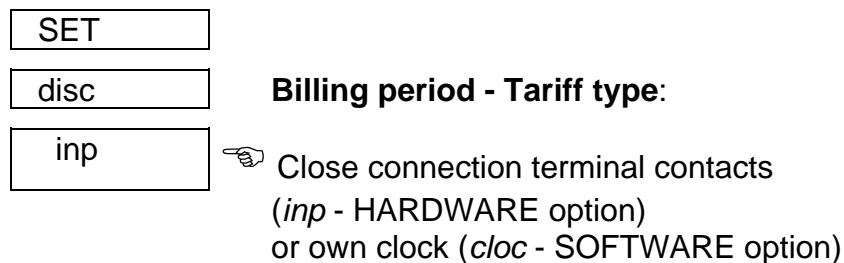

- "**max**": allows the modification of the selected option.
- "**display**": allows the validation of the selected option.

(1) A power demand controller with external synchronism time and fixed window is selected. The integrated value until that moment is displayed.

NOTE : If no pulse is received after a time equal to a +10 % of the programmed period it passes to work in the sliding window mode, and returns to the fixed window mode when it receives a new synchronism pulse.

(2) Power demand controller with the sliding window mode (no synchronism). The integrated value for the last period from that moment is displayed.

- **DB-9 OUTPUT:** It has the same features that a CVM/RED module. Its connection is like shown at the previous sections.

COMMUNICATIONS COMMANDS WITH THE CVM / RED-MAX MODULE
(*) negative energies only for the CVMk-H- 4C (four quadrants).

COM..	CONCEPT	QUESTION	ANSWER	UNIT
RWHXn (*)	Read active energy (positive, negative - absolute value -)	\$pp RWHXn ch	\$pp a x 9 digits ch \$pp 2a x 9 dig ch	W. h
RLHXn (*)	Read inductive energy (positive, negative - absolute value -)	\$pp RLHXn ch	\$pp a x 9 digits ch - For the CVMk-H-4C : \$pp 2a x 9 dig. ch	varh . L
RCHXn (*)	Read capacitive energy (positive, negative - absolute value)	\$pp RCHXn ch	\$pp a x 9 digits ch - For the CVMk-H-4C : \$pp 2a x 9 dig. ch	varh. C
RCEXn	Read initial value of the positive energies: kW.h, Kvarh.L and kvarh.C	\$pp RCEXn ch	\$pp 3a x 9 digits ch	W.h
WCEXn	Write the three positive energies (write initial value).	\$pp WCEXn 3a x 9 digits ch	\$pp ACK ch	W.h
(*) RCEXn	Read initial value of the negative energies: kW.h, kvarh.L and kvarh.C	\$pp RCEXn ch	\$pp 3a x 9 digits ch	W.h
(*) WCEXn	Write the absolute value of the three negative energies (write initial value).	\$pp WCEXn 3a x 9 digits. ch	\$pp ACK ch	W.h
RTS	Read SET-UP of three billing period operation mode (CVM/ RED-MAX module)	\$pp RTS ch	\$pp 3 digits ch arg: 1d. tariff/ clock +1 Syncro/clock +1 active tariff type	

- MAXIMUM POWER DEMAND COMMANDS

COM.	CONCEPT	QUESTION	ANSWER
CMDXn	Delete maximum demand value pd=0	\$pp CMDXn ch	\$pp ACK ch
RMDXn	Read maximum demand value: DATE, MAXIMUM (from the last reset), LAST PERIOD MAXIMUM	\$pp RMDXn ch	\$pp 35 digits ch xx/xx/xx xx:xx:xx xxxxxxxxx (9 dig) xxxxxxxxx (9 dig)

 - "n" is the tariff number :

- 0 ----- Tariff 1**
- 1 ----- Tariff 2**
- 2 ----- Tariff 3**
- 3 ----- The three tariffs**

- "a" (the size of the answer)
 - a = 1 if n = 0, 1 or 2
 - a = 3 if the value n = 3

Examples : To ask the three kW. h counters
\$00RWHX3 [ch] [LF]

9.6.- APPENDIX F : MODBUS © protocol

The CVMk-H power meter has also the **MODBUS** © protocol .

When the CVMk-H is configured to work with MODBUS protocol , it use the **RTU mode** (Remote terminal Unit) . Each 8-bit byte in a message contains two 4-bits hexadecimal characters.

The format for each byte in RTU mode is :

- * *Code* : **8-bit binary** , hexadecimal 0-9, A-F
Two hexadecimal characters contained in each 8-bit field of the message .
- * *Bits per Byte* : 8 data bits
- * *Error Check Field* : Cyclical Redundancy Check (**CRC**) .

MODBUS FUNCTIONS :

FUNCTION 3 or 4 Reads the n Words (16 bits- 2 bytes) . It uses this function to read all the electrical parameters of the CVMk-H. This registers are longs of 32 bits ; In this case It is necessary to read two Words.
(4 bytes - XX XX XX XX).

FUNCTION 6 Writing of 1 Word. This function is used to change from MODBUS to CIRBUS.

Valid Register 0
Valid value 0

Registers of the CVMk-H electrical parameters :

<i>VARIABLE</i>	<i>REGISTERS</i>	
	<i>DECIMAL</i>	<i>HEXA-DECIMAL</i>
DATE / HOUR *NOTE 1	0 - 1	00 - 01
V 1	2 - 3	02 - 03
mA 1	4 - 5	04 - 05
W 1	6 - 7	06 - 07
varL 1	8 - 9	08 - 09
varC 1	10 - 11	0A - 0B
PF 1 (x100)	12 - 13	0C - 0D
V 2	14 - 15	0E - 0F
mA 2	16 - 17	10 - 11
W 2	18 - 19	12 - 13
varL 2	20 - 21	14 - 15
varC 2	22 - 23	16 - 17
PF 2 1 (x100)	24 - 25	18 - 19
V 3	26 - 27	1A - 1B
mA 3	28 - 29	1C - 1D
W 3	30 - 31	1E - 1F
varL 3	32 - 33	20 - 21
varC 3	34 - 35	22 - 23
PF 3 1 (x100)	36 - 37	24 - 25

<i>VARIABLE</i>	<i>REGISTERS</i>	
	<i>DECIMAL</i>	<i>HEXA-DECIMAL</i>
Vav III N	38 - 39	26 - 27
mAav III	40 - 41	28 - 29
W III	42 - 43	2A - 2B
varL III	44 - 45	2C - 2D
varC III	46 - 47	2E - 2F
PF III 1 (x100)	48 - 49	30 - 31
Hz (x10)	50 - 51	32 - 33
VA III	52 - 53	34 - 35
V 12	54 - 55	36 - 37
V 23	56 - 57	38 - 39
V 31	58 - 59	3A - 3B
Vav III	60 - 61	3C - 3D
+ Wh - TARIFF 1	62 - 63	3E - 3F
+ varh L -TAR. 1	64 - 65	40 - 41
+ varh C -TAR. 1	66 - 67	42 - 43
Pd (last period)	68 - 69	44 - 45
- Wh TARIFF 1	70 - 71	46 - 47
- varh L TAR. 1	72 - 73	48 - 49
- varh C TAR. 1	74 - 75	4A - 4B

WARNING! The negative values are to be calculated using 2C algorithm over the received data.

<i>VARIABLE</i>	<i>REGISTERS</i>	
	<i>DECIMAL</i>	<i>HEXA-DECIMAL</i>
THD V 1	84 - 85	54 - 55
THD V 2	86 - 87	56 - 57
THD V 3	88 - 89	58 - 59
THD I 1	90 - 91	5A - 5B
THD I 2	92 - 93	5C - 5D
THD I 3	94 - 95	5E - 5F
DATE / HOUR *NOTE 1	100 - 101	64 - 65
V 12	102 - 103	66 - 67
V 23	104 - 105	68 - 69
V 31	106 - 107	6A - 6B
V 1	108 - 109	6C - 6D
V 2	110 - 111	6E - 6F
V 3	112 - 113	70 - 71

<i>VARIABLE</i>	<i>REGISTERS</i>	
	<i>DECIMAL</i>	<i>HEXA-DECIMAL</i>
mA 1	114 - 115	72 - 73
mA 2	116 - 117	74 - 75
mA 3	118 - 119	76 - 77
W 1	120 - 121	78 - 79
W 2	122 - 123	7A - 7B
W 3	124 - 125	7C - 7D
varL 1	126 - 127	7E - 7F
varL 2	128 - 129	80 - 81
varL 3	130 - 131	82 - 83
+ Wh - TARIFF 1	132 - 133	84 - 85
+ varh L -TAR. 1	134 - 135	86 - 87
- Wh TARIFF 1	136 - 137	88 - 89
- varh L TAR. 1	138 - 139	8A - 8B

***NOTE 1**

* The DATE / HOUR register has the next format :

b0 - b5 seconds
 b6 - b11 minutes
 b12 - b16 hours
 b17 - b21 day
 b22 - b25 month
 b26 - b31 year + 92

Energy registers (three tariffs) :

<i>VARIABLE</i>		<i>REGISTERS</i>	
		<i>DECIMAL</i>	<i>HEXADECIMAL</i>
DATE / HOUR * NOTE 1	TARIFF	200 - 201	C8 - C9
+ Wh	1	202 - 203	CA - CB
+ varh L	1	204 - 205	CC - CD
+ varh C	1	206 - 207	CE - CF
- Wh	1	208 - 209	D0 - D1
- varh L	1	210 - 211	D2 - D3
- varh C	1	212 - 213	D4 - D5
Pd (Date and hour of the maximum demand value) *NOTE 1	1	214 - 215	D6 - D7
Pd (Maximum demand value)	1	216 - 217	D8 - D9
Pd (Last period maximum)	1	218 - 219	DA - DB
+ Wh	2	220 - 221	DC - DD
+ varh L	2	222 - 223	DE - DF
+ varh C	2	224 - 225	E0 - E1
- Wh	2	226 - 227	E2 - E3
- varh L	2	228 - 229	E4 - E5
- varh C	2	230 - 231	E6 - E7
Pd (Date and hour of the maximum demand value) *NOTE 1	2	232 - 233	E8 - E9
Pd (Maximum demand value)	2	234 - 235	EA - EB
Pd (Last period maximum)	2	236 - 237	EC - ED
+ Wh	3	238 - 239	EE - EF
+ varh L	3	240 - 241	F0 - F1
+ varh C	3	242 - 243	F2 - F3
- Wh	3	244 - 245	F4 - F5
- varh L	3	246 - 247	F6 - F7
- varh C	3	248 - 249	F8 - F9
Pd (Date and hour of the maximum demand value) *NOTE 1	3	250 - 251	FA - FB
Pd (Maximum demand value)	3	252 - 253	FC - FD
Pd (Last period maximum)	3	254 - 255	FE - FF

EXAMPLE

QUERY

0A 03 00 26 00 10 A4 B6

0A	CVMk-H number, 10 in decimal
03	Reading function
00 26	Starting address (first register)
00 10	Number of registers for reading
A4B6	CRC character

RESPONSE

**0A 03 20 00 00 00 D4 00 00 23 28 00 00 0F A0 00 00 00
00 00 00 00 00 00 00 00 60 00 00 01 F4 00 00 0F A0
B7 8B**

0A	CVMk-H number , 10 in decimal
03	Reading function (03 or 04).
20	Data response bytes
00 00 00 D4	Vav III (register 26 Hex) in decimal 212 V
00 00 23 28	mA av III in decimal 9000 mA
00 00 0F A0	W III in decimal 4000 W
00 00 00 00	varL III in decimal 0 varL
00 00 00 00	varC III in decimal 0 varC
00 00 00 60	PF in decimal 96 PF
00 00 01 F4	Hz in decimal 50 x 10 -> 50 Hz
00 00 0F A0	VA III in decimal 4000 mA
B7 B8	CRC character

MODBUS SELECTION

There are two ways for the change of the protocol (CIRBUS or MODBUS) :

a.- It is possible to access to a second MENU of SET-UP that allows the configuration of the CVMk-H : CIRBUS or MODBUS
(* see the **APPENDIX B**.)

b.- With instructions via RS.

b.1.- When the device is on CIRBUS , for changing to MODBUS via RS, it is done sending the command **MBS**.

CIRBUS -> MODBUS	\$PP MBS ch (Lf)	ASCII
PP	Peripheral number (CVMk-H)	
MBS	Instruction to change from CIRBUS to MODBUS	
ch	CHECK SUM	

b.2.- When the device is on MODBUS , for changing to CIRBUS via RS, it is necessary to use the **FUNCTION 6** (Writing of 1 Word) .

MODBUS -> CIRBUS	PP 06 00000000 CCCC	BINARY
PP	Peripheral number (CVMk-H)	
06	Writing function (Only to change).	
0000	Writing of 1 Word	
0000	Writing register : 0	
CCCC	CRC	