



SUPPLY NETWORK ANALYZER

CVM-SP SERIES

INSTRUCTION MANUAL

(M 981 310 / 01A)

(c) CIRCUTOR S.A.

1.- MAIN FEATURES	2
1.1.- Parameters measured and calculated by CVM-SP.	3
1.2.- CVM-SP types.	3
2.- INSTALLATION AND START-UP	4
2.1.- Connection arrangement.....	5
2.2.- Connection terminal arrangement.....	7
2.3.- Connection diagram of a CVM-SP to a single-phase power system:	8
3.- OPERATION MODE.....	9
4.- SPECIFICATIONS.....	10
5.- SAFETY WARNINGS.....	13
6.- MAINTENANCE.....	13
7.- TECHNICAL SERVICE	14
A.- CVM-SP-RS485-C COMMUNICATIONS	15
A.1.- Communication parameters	15
A.2.- To take into account!:	16
A.3.- MODBUS © Protocol.....	17
A.3.1.- Communication setting	18
A.3.2.- Reading parameters measured by the CVM-SP	20
A.3.3.- Reading digital outputs (relays):.....	21
A.3.4.- Reset to zero (Energy, maximum demand...).....	22
A.3.5.- Setting maximum demand function:	23
A.3.6.- Setting Alarm / Pulses:.....	24



The manual you hold in your hands contains information and warnings about the **CVM-SP** that the user should respect in order to guarantee a proper operation of all the instrument functions and keep its safety conditions.

1.- MAIN FEATURES

The CVM-SP is a single-phase, true R.M.S. value, measuring instrument. This instrument is equipped with a display for the indication in a sequential mode of diverse parameters measured and calculated from the monitored power system.

According to the CVM-SP model, a built-in RS485 communication bus (for data transference to a PC) and a user-programmable relay output for pulse or alarm purposes are also delivered with the instrument.

1.1.- Parameters measured and calculated by CVM-SP.

By means of an internal microprocessor, following parameters can be simultaneously monitored:

<i>Parameter</i>	<i>Symbol</i>	<i>Parameter</i>	<i>Symbol</i>
Voltage	<i>V</i>	Power factor	<i>PF</i>
Current	<i>A</i>	Frequency	<i>Hz</i>
Active power	<i>kW</i>	Maximum demand	<i>Pd</i>
Reactive power	<i>kvarL /(-C)</i>	kW. h	<i>energy</i>
Voltage THD	<i>% THD- V</i>	kvarh. L	<i>energy</i>
Current THD	<i>% THD- A</i>	kvarh. C	<i>energy</i>

1.2.- CVM-SP types.

Type	Currents	Hardware Setting	Code
CVM-SP	25A	0232	770 480
	100A	0230	770 484
CVM-SP-RS485-C (Communications and output relay)	25A	1332	770 481
	100A	1330	770 485

All CVM-SP types do measurements over two quadrants:
only facilities consuming energy.

2.- INSTALLATION AND START-UP

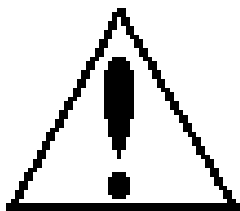

The manual you hold in your hands contains information and warnings that the user should respect in order to guarantee a proper operation of all the instrument functions and keep its safety conditions.

The instrument must not be powered and used until its definitive assembly on the cabinet's door.

Whether the instrument is not used as manufacturer's specifications, the protection of the instrument can be damaged.

When any protection failure is suspected to exist (for example, it presents external visible damages), the instrument must be immediately powered off. In this case contact a qualified service representative.

2.1.- Connection arrangement

Before powering the instrument for the first time, verify following points:

a.- **Power supply/measuring voltage:** see lable on the instrument side.

- **Standard power supply:** Single-phase **230 V** ~ (a.c.)
- **Frequency** : 50 - 60 Hz
- **Power supply tolerance** : + 15 / - 10 %
- **Instrument burden** : 3 VA

b.- Maximum admissible current: see lable on the instrument side

c.- Operation conditions:

- Working temperature range: -10 °C to +50 °C
- Relative humidity : 5 a 95 % RH (non-condensing)
- Height : until 2000 m

d.- Safety:

- Protection against electric shock by class II double-isolation
- Designed for class III facilities - 300 V a.c (EN 61010).



Mounting : 

The instrument is to be mounted onto a DIN rail. All wiring connections keep inside the switchboard cabinet.

Note that with the instrument powered on, the terminals could be dangerous to touching and cover opening actions or elements removal may allow accessing dangerous parts. Therefore, the instrument must not be used until this is completely installed.

The monitored line should be provided with a circuit breaker or any equivalent element (fuses) to connect (ON) or disconnect (OFF) the instrument from the power supply network. This switching device must be placed near the instrument and will be easily accessible. The instrument is directly power supplied from the cables crossing the CVM. The power supply and voltage-current measuring circuit must be wired with cables of appropriate cross-section according to the current flowing through the CVM.

2.2.- Connection terminal arrangement

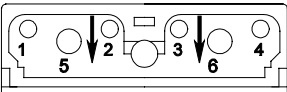
	Terminal No.	Terminal description
	1	<i>RS-485 (-)</i> (Acc. to type)
	2	<i>RS-485 (+)</i> (Acc. to type)
	3	<i>Relay RL1 output</i> (Acc. to type)
	4	<i>Relay common</i> (Acc. to type)
	5	<i>Voltage/Current L1 input</i>
	6	<i>Voltage N/L2 input</i>

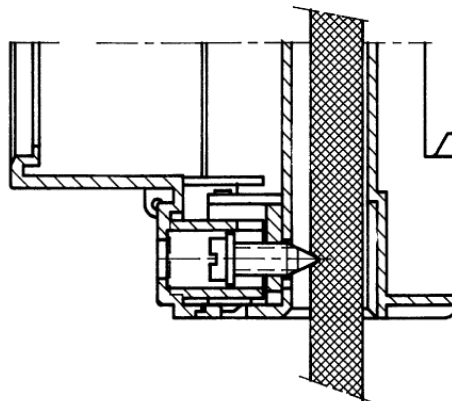

DETAIL OF THE VOLTAGE MEASURING MODE

2.3.- Connection diagram of a CVM-SP to a single-phase power system:

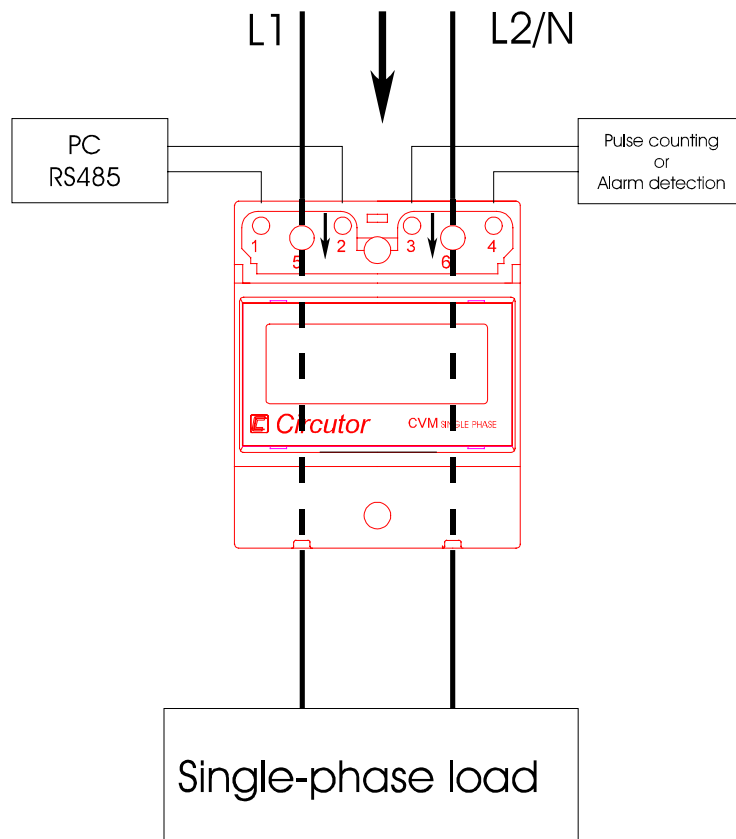

3.- OPERATION MODE

The instrument is equipped with a display for the automatic and sequential indication of readouts of diverse parameters measured by the analyzer.

When the CVM-SP is powered on, the displays shows "xxxx", this number refers to the program and setting version. After some seconds, the analyzer is ready for its normal operation and one of possible screens is shown by display. The indicator of the parameter on display is on.



Mechanical features :

- Case type : Modular of self-extinguishing plastic
- Current cable entrance : Maximum Ø 11 mm
- Voltage connection : Metallic terminal with
"pozidriv" No.2 / flat mixed screw.
- Realy and RS-485 output: Metallic terminal with flat headed screw.
- Mounting : Symmetric DIN 46277 (EN50022) rail
- Protection : CVM assembled in cabinet: IP 41 / Terminals: IP 20
- Dimensions : 70 x 80 x 75 mm (4-module relay - DIN 43 880)
- **Weight : 0.250 kg.**

Output relay characteristics : According to type

- Maximum switching load : 750 VA
- Maximum switching voltage : 250 V a.c.
- Maximum switching current : 3 A
- Mechanical endurance : 2×10^7 operations
- Energy / alarms pulses : Max. 1 pulse/s

At full load:

- Electrical endurance (250 V a.c. / 3 A) : 1×10^5 operations
- Safety Class III - 300 V a.c. , EN-61010

Protection against electric shock by class II double-isolation 

Standards : IEC 664, VDE 0110, UL 94, IEC 801, IEC 348, IEC 571-1
EN 50081-1, EN 50082-1, EN-61010-1

Dimensions :

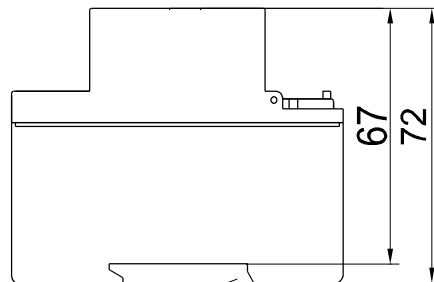
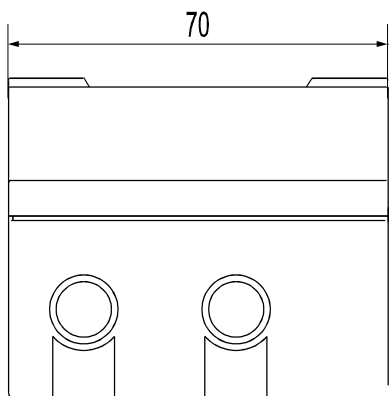

Fixing on to rail
DIN 46277 (EN 50022)

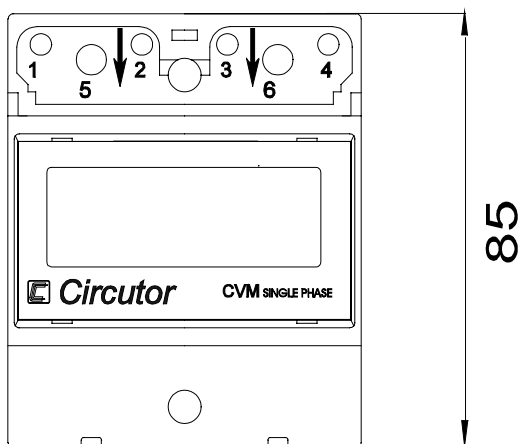

5.- SAFETY WARNINGS

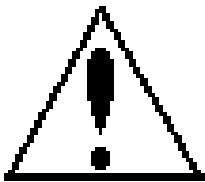

All installation specification described at the previous chapters named INSTALLATION AND STARTUP, INSTALLATION MODES and SPECIFICATIONS.

This instrument has been designed according to EN-61010 standard and is factory-shipped at proper operation conditions.

6.- MAINTENANCE

The CVM-SP does not require any special maintenance.

Before any adjustment, replacement, maintenance or repairing operation is carried out, the instrument must be disconnected from any power supply source.

When any protection failure is suspected to exist, the instrument must be immediately put out of service. The instrument's design allow a quick replacement in case of any failure.

7.- TECHNICAL SERVICE

For any inquiry about the instrument performance or whether any failure happens, contact to CIRCUTOR's technical service.

*CIRCUTOR S.A. - After-sales service
c / Lepanto , 49
08223 - TERRASSA
Tel - + 34 93 745 29 00
fax - + 34 93 745 29 14
E-mail : central@circutor.es*

A.- CVM-SP-RS485-C COMMUNICATIONS

One or several CVM-SP-RS485-C can be connected to a P.C.. With this system we can get all the parameters in one central point of reading. If we connect more than one device to the same communication line, we have to assign to each of them a different code or direction, since the P.C. needs the identification of every measuring point.

A.1.- Communication parameters

When powering the CVM-SP-RS485 on, three different screens will be sequentially shown by display. These screens indicate divers instrument identification parameters; the third screen will indicate the peripheral number (code or direction) and communication parameters of the unit.

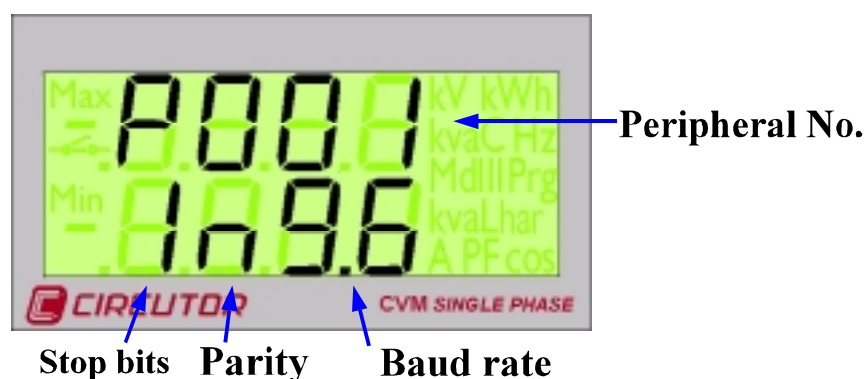

A.2.- To take into account!:

- **PROTOCOL:** MODBUS © (Question / Answer)
- **CVM-SP DEFAULT CONFIGURATION :** 001/9.600/8/N/1
- Available baud rates: 1.200 - 2.400 - 4.800 - 9.600 - 19.200
- **RS-485 type output:**

Terminal No. Signal

2	-----	TX +
1	-----	TX --

-RS-485 connection will be carried out by means of a **twisted and screened cable**, with a minimum of 3 wires, with a maximum distance between the CVM-SP and the last peripheral of 1.200 m. The CVM-SP uses a RS-485 communication bus allowing up to a **maximum of 32 devices in parallel (Multi-point bus) per port used in the PC.**

A.3.- MODBUS © Protocol

The CVM-SP analyzer can communicate by means of the **MODBUS-RTU** protocol (Remote Terminal Unit), as it is following described:

The format for each byte in RTU mode is :

- * *Code* : **8-bits binary**, hexadecimal 0-9, A-F
Two hexadecimal characters
contained in each 8-bits field of the message.
- * *Bits per Byte* : 8 data bits
- * *Error Check Field* : Cyclical Redundancy Check (**CRC**).

MODBUS FUNCTIONS ENABLED IN THE CVM-SP :**FUNCTION 01** Reading of relay status**FUNCTION 3 or 4** Reading of n Words (16 bits-2 bytes). This function permits to read all the electrical parameters of the CVM-SP. Each parameters is a 32-bits long, hence two words are required to inquiry for a parameter.**FUNCTION 16 (10 Hex):** Writing multiple integer registers.**A.3.1.- Communication setting**

Read communication parameters	NP0403E80003CRC
Answer	NP0406aabbccddeeffCRC

Write communication parameters	NP1003E8000306aabbccddeeffCRC
Answer	NP1003E80003CRC

Where:

	Description	Value					
NP	Peripheral number						
aa	Modbus	00					
bb	Peripheral No.	01-FF (01-256 Hexadecimal)					
cc	Baud rate	00	1200	02	4800	04	19200
		01	2400	03	9600(def.)	05	38400
dd	Parity	00	No	01	Even	02	Odd
ee	Data bits	08					
ff	Stop bits	00	1 Stop bit	01	2 Stop bit		

Modbus functions enabled in the instrument do not check that stored parameters are inside correct ranges, therefore, in case that any parameter with an incorrect value is stored, the instrument will be set with the default value for this parameter. The new stored configuration will not be effective until a reset action is done.

A.3.2.- Reading parameters measured by the CVM-SP

<i>PARAMETER</i>	<i>Code</i>	<i>Units</i>	<i>MODBUS REGISTERS HEXADECIMAL (longs)</i>		
			<i>Value PRESENT</i>	<i>Value MAXIMUM</i>	<i>Value MINIMUM</i>
Voltage	1	V x 10	00-01	60-61	C0-C1
Current	2	mA	02-03	62-63	C2-C3
Active power	3	W	04-05	64-65	C4-C5
Reactive power	4	var	06-07	66-67	C6-C7
Power factor	5	PF x 100	08-09	68-69	C8-C9
Cos ϕ	6	Cos ϕ x 100	0A-0B	6A-6B	CA-CB
Frequency	7	Hz x 10	0C-0D	6C-6D	CC-CD
%THD V	8	% x 10	0E-0F	6E-6F	CE-CF
%THD I	9	% x 10	10-11	70-71	D0-D1
Active energy	10	W. h	12-13	72-73	D2-D3
Inductive reactive energy	11	var.h L	14-15	74-75	D4-D5
Capacitive reactive energy	12	var.h C	16-17	76-77	D6-D7
Apparent power	13	VA	18-19	78-79	D8-D9
Maximum demand (Pd)	14	W - VA	1A-1B	7A-7B	DA-DB

EXAMPLE**INQUIRY 0A 04 00 00 00 0A 71 76**

0A	CVM-SP peripheral number, 10 in decimal
04	Reading function
00 00	Initial address (first register)
00 0A	Number of registers to be read
7176	CRC character

**ANSWER 0A 04 14 00 00 08 4D 00 00 23 28 00 00
0F A0 00 00 00 90 00 00 00 60 CB 2E**

0A	Answering CVM-SP number , 10 in decimal
04	Reading function – the one use for the inquiry
14	Bytes received (20)
00 00 08 4D	V 1x10 (register 00 Hex), in decimal 212.5 V
00 00 23 28	mA 1, in decimal 9000 mA
00 00 0F A0	W 1, in decimal 4000 W
00 00 00 90	varL 1, in decimal 144 varL
00 00 00 60	PF x 100, in decimal 96
CB 2E	CRC character

A.3.3.- Reading digital outputs (relays):

Read relay status	NP0100000008CRC
Answer	NP0101XXCRC

NP → Peripheral number.

XX (hexadecimal byte) → to binary

b7	b6	b5	b4	b3	b2	b1	b0
----	----	----	----	----	----	----	-----------

bit **b0** = relay 1 (1 = ON; 0 = OFF)

A.3.4.- Reset to zero (Energy, maximum demand...)

Action	Inquiry	Answer
Reset	NP0507D0FF00CRC	No answer
Erasing energies	NP050834FF00CRC	NP050834FF00CRC
Erasing maximum demand	NP050835FF00CRC	NP050835FF00CRC
Erasing maximum and minimum values.	NP050836FF00CRC	NP050836FF00CRC

NP: Peripheral No.

A.3.5.- Setting maximum demand function:

Writing maximum demand	NP1004E2000204aaaabbbbCRC
Answer	NP1004E20002CRC

Reading maximum demand	NP0404E20002CRC
Answer	NP0404aaaabbbbCRC

Where:

	Description	Value
NP	Peripheral number	
aaaa	Pd monitored parameter	0 No Pd 3 kW 13 kVA
bbbb	Integration period	1 - 60 min (In Hexadecimal)

A.3.6.- Setting Alarm / Pulses:

Writing setting	NP10047E00060Caaaaaaaaabbbbbbbccc cddeeCRC
Answer	NP10047E0006CRC

Reading setting	NP04047E0006CRC
Answer	NP040CaaaaaaaaabbbbbbbcccdddeeCRC

Where:

	Description	Value
NP	Peripheral number	
aaaa aaaa	MAX value or Energy pulse	According to parameter (0 by default)
bbbb bbbb	MIN value	According to parameter (0 by default)
cccc	Delay	0 to 9999 (0 by default)
dd	Parameter number	0-14
ee	Not used	Any value

1. Setting relay outputs

- **Pulse every certain kWh or kvarh (ENERGY).** You can define the value corresponding to the energy consumed for generating a pulse (0.5 s long): kWh / 1 pulse or kvarh / 1 pulse
- **ALARM conditions:** the parameter to be controlled, the maximum value, the minimum value and the delay are user-definable for each relay output.

CVM-SP default configuration:

- ◆ **Parameter number: 10 → Active Energy**
- ◆ **Pulse: 0.010 → 10 W**

1 pulse/ 10 W → 100 pulses / 1 kW

ALARM ACTIVATION: Alarms operation depend on the set values of MAXIMUM and MINIMUM.

MAX > MIN	<p style="text-align: center;">ON OFF ON</p> <p style="text-align: center;"> </p>
MAX < MIN	<p style="text-align: center;">OFF ON OFF</p> <p style="text-align: center;"> </p>

ON = alarm activated -----> relay closed
 OFF = alarm deactivated -----> relay open

The **DELAY** set value is applied either to the connection or the disconnection when the alarm conditions occur.