



## **SYSTEM ANALYZER**

**C-80**

## **INSTRUCTION MANUAL**

**(M98117501-03 / 03D)**

**(c) CIRCUTOR S.A.**

**C-80 TABLE OF CONTENTS**

1.- INTRODUCTION ..... 3

2.- GENERAL FEATURES..... 4

3.- CONNECTION AND START-UP..... 5

    3.1.- Values measured in balanced three phase mode and single phase mode ..... 6

    3.2.- Connection diagrams ..... 7

        3.2.1.- Connecting a current clamp ..... 9

    3.3.- Functions of the keypad..... 9

    3.4.- Starting measuring with the C-80..... 10

    3.5.- Presentation of data on the display ..... 11

4.- PROGRAMMING AND PARAMETER DISPLAY..... 13

    4.1.- Basic setting diagram ..... 13

    4.2.- Measurement menu..... 14

    4.3.- SETUP menu..... 16

    4.4.- Capacitor mode ..... 18

    4.5.- CLEAR mode..... 19

    4.6.- Registering menu ..... 20

        4.6.1.- Timed registers ..... 21

        4.6.2.- Instant registering ..... 21

    4.7.- Additional current leakage screen..... 23

5.- TECHNICAL FEATURES: ..... 24

6.- FREQUENTLY ASKED QUESTIONS ..... 25

7.- MAINTENANCE..... 26

8.- TECHNICAL SERVICE..... 26



## 1.- INTRODUCTION.

The **C-80** analyzer is a programmable, measuring instrument that **measures, calculates and records in the memory** the main electrical parameters in single phase or balanced three phase with neutral, industrial systems. It is a small, portable and light instrument that measures in true RMS.

The equipment has been manufactured with the latest technology and is the most advanced means of measuring and recording electrical parameters on the market.

The **C-80** analyzer allows automatic recording with a programmed time, and also, instantly (or simultaneously) records data in the internal memory at regular time intervals.

This manual assists in the installation and use of **C-80** type measuring instruments and helps to obtain the best service from it. **Carefully read this manual before connecting the equipment** to avoid incorrect use which may cause irrevocable damage.



For the safe use of the **C-80** it is vital that those persons installing it or handling it follow the usual safety procedures as well as the individual warnings in this instruction manual, as well as the different warnings it contains.

If the equipment is used in a way not specified by the manufacturer, the equipment's protection may be compromised.

## 2.- GENERAL FEATURES

- It is a small, lightweight portable measuring instrument.
  - Measurement of the main electrical parameters in single phase balanced three phase and unbalanced three phase with neutral systems.
  - Measurement in true RMS.
  - Instant, maximum and minimum values.
  - Measurement incorporated energy.
  - Inductive system generated reactive power correction calculations.
  - Measurement of the harmonic distortion in voltage and current (% THD V / I) with visual alarm visual if the user set THD is exceeded.
- Option to take automatic data recordings in the internal memory at regular time intervals.

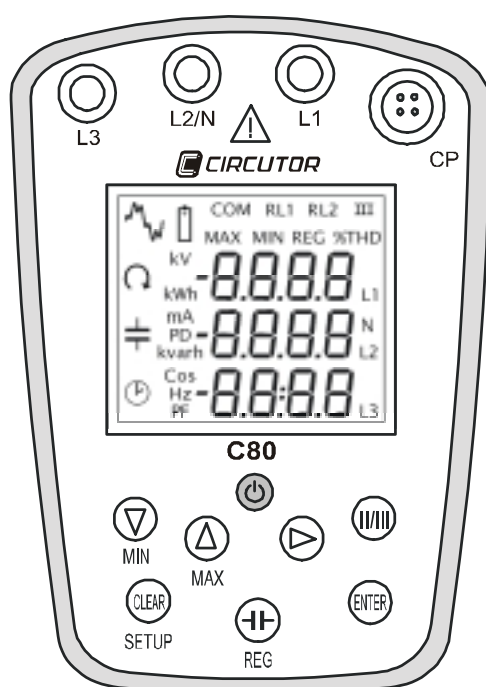

**Setting:** Setting the equipment is done via a system of menus and modes that the user may configure.

**Display:** Using its liquid crystal (LCD) 7 segment 3 line and 4 digits per line with indicating icons. The instant maximum, minimum values, recorded values and THD alarms can be displayed.

**Power supply:** The C-80 Analyzer is powered by two standard 1.5 V AA type batteries. The independent operating period is about 200 hours. The equipment switches itself off after 5 minutes if not recording.

### 3.- CONNECTION AND START-UP

Before connecting the equipment, check the following:

- a) Frequency: 45...65 Hz.
- b) Maximum voltage in the measurement circuit:
  - 500 V AC. between voltage inputs.
- c) Maximum measurable current: according to clamps used.
- d) Whenever a clamp is connected, the **C-80** auto-detects the clamp and stores the configuration (Current primary) of the clamp automatically in the setup. This does not occur with the CP-5 clamp. This is due an external transformer that has to manually programmed.

If the clamp detected has 2 scales, the equipment goes into setup mode and the scale may be changed with the cursors [▼] [▲] and then entered with the [ENTER] key.

Ammeter clamps	Measurement range
CP-2000-200	8 to 2000 A AC. (2000 A range) 0.8 to 200 A AC. (200 A range)
CPR-1000	4 to 1000 A AC.
CPR-500	2 to 500 A AC.
CP-100 (M1-U)	0.4 mA to 100 A AC.
CP-5	20 mA to 5 A AC.
CPF-5 (Leaks)	10 mA to 5 A AC.
C-FLEX 200-2000-20000 (Flexible clamps)	8 to 2000 A AC. Clamp with auto-scale Changing the scale is automatic depending on the current measured. e.g. 190 A, 200 A range 250 A, 2000 A range

**NOTE:** For better accuracy it is advised to always measure the highest part of the scale.

### 3.1.- Values measured in balanced three phase mode and single phase mode

In three phase mode, the three phases must be connected in the correct fashion plus a current clamp to measure current. The C-80 measures power consumed.

Parameter	Symbol	Balanced three phase value			Single phase value		
		Instant	Max	Min	Instant	Max	Min
Voltage	<i>V</i>	x	x	x	x	x	x
Current	<i>A</i>	x	x		x	x	
Frequency	<i>Hz</i>	x	x	x	x	x	x
Active Power	<i>W</i>	x	x		x	x	
Reactive power	<i>var</i>	x	x		x	x	
Power Factor	<i>PF</i>	x	x		x	x	
Cos φ / P.F.	<i>cos φ</i>	x	x		x	x	
Active energy	<i>w</i>	x			x		
Reactive energy (L)	<i>VarhL</i>	x			x		
Reactive energy (C)	<i>VarhC</i>	x			x		
THD (%) V, I	<i>%THD</i>	x	x		x	x	
Power Demand	<i>PD</i>	x	x		x	x	

**NOTE:** the three phase system power is calculated as: 
$$U_{12} \times I_3 \times \sqrt{3}$$



This manual has information and warnings that the user must follow to ensure the safe operation of the equipment and to maintain it in good condition in terms of safety.

If the equipment is used in a way not specified by the manufacturer, the equipment's protection may be compromised. Bear in mind that when the equipment is connected, opening the covers or removing parts may access dangerous parts.

If it is likely that there has been a loss in protection (for example if there are visible signs of damage) the equipment must not be handled. In this event please contact a qualified service representative.

### 3.2.- Connection diagrams

#### - Balanced three phase connection system:

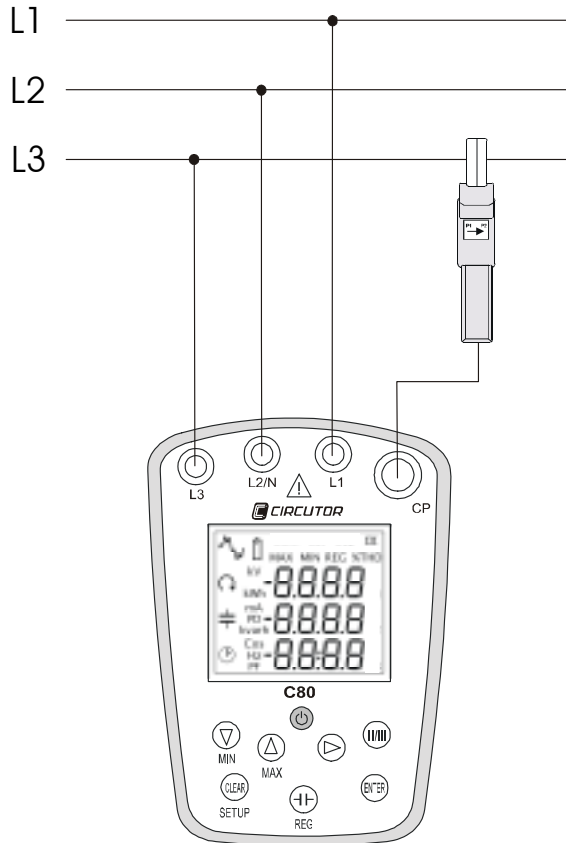

L1	Voltage Line 1
L12/N	Voltage Line 2
L3	Voltage Line 3
CP	Current clamp

#### - Single phase connection system:

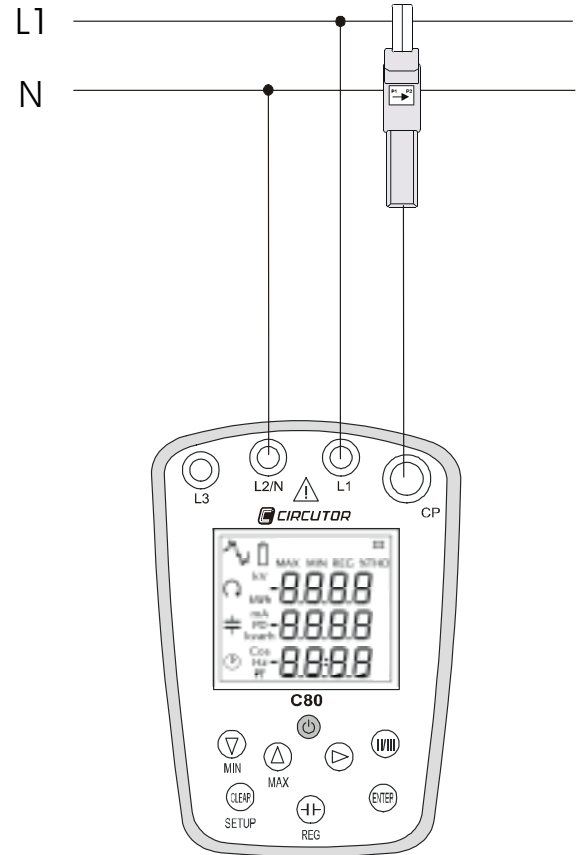

L1	Voltage Line
L12/N	Neutral
CP	Current clamp

**NOTE:** The L1 and L2 voltage terminal connections take the measurement. The L3 terminal is for checking the turn direction of the phases (1→2→3). If the phases are incorrectly connected the C-80 will display the prescribed turning direction. (See section 3.5 Presentation of data on the display).

**- Unbalanced three phase with neutral connection:**

The **C-80** can take measurements of an unbalanced three phase with neutral system. To do this, measurements will have to be taken in each of the three phases separately, as though a single phase system was being measured:

1. V1-N / I1
2. V2-N / I2
3. V3-N / I3

The C-80 will measure values per phase. If the total power (W or var) is required the measured powers the measured powers have to be added  $P1 + P2 + P3$ .

To calculate the kvar(L) of an unbalanced system with neutral, the phase with the highest inductive load has to be found and then multiply that by three to find the suitable capacitor bank value.

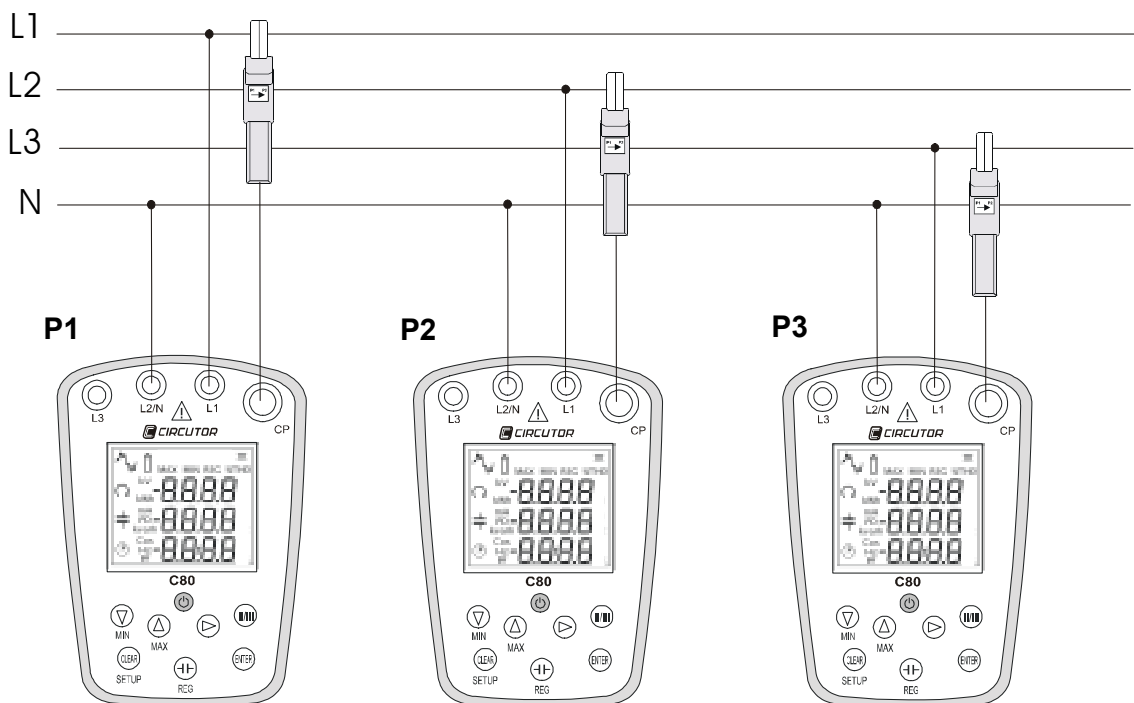

**NOTE:** Measurements cannot be taken in an unbalanced three phase system without neutral.



### 3.2.1.- Connecting a current clamp

The user does not need to concern himself with the direction of the current clamp. If the direction of the current is unknown, the **C-80** internally changes the direction so that it always measures power consumed

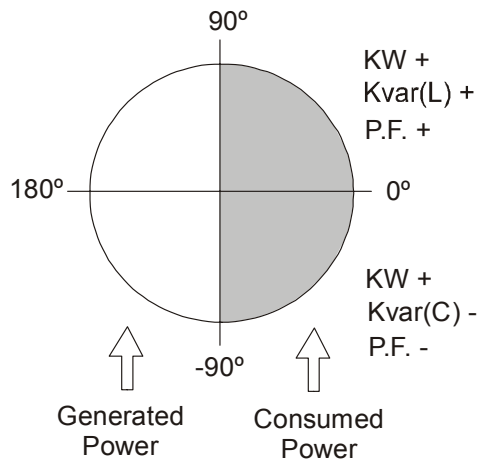

### 3.3.- Functions of the keypad

**C-80** Analyzers have a membrane keypad with 8 keys to set and control the equipment's different options. Some keys have a double function that can be selected by a short or long press (about 3 seconds).

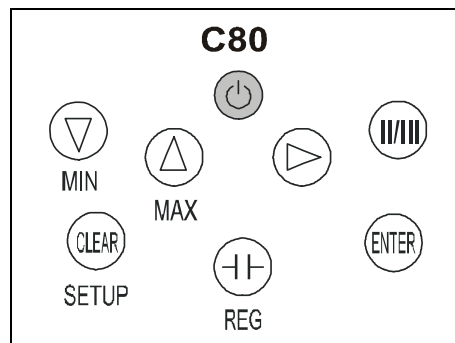

#### Short press:

- **[ON/OFF]** to switch on/off the C-80.
- **[▼], [▲]** and **[▶]** To move between, edit and select several options.
- **[II/III]** The user can change between single phase mode and three phase mode.
- **[H]** Access to Reactive power mode calculation.
- **[CLEAR]** Access to CLEAR use (deletion of max./min., energies and recordings).
- **[ENTER]** Starts recording and entering action.

#### Long press:

- **[MIN]** for 3 seconds the maximum value is displayed.
- **[MAX]** for 3 seconds the maximum value is displayed.
- **[REG]** Access to registering menu.
- **[SETUP]** Access to SETUP menu.

### 3.4.- Starting measuring with the C-80

1. To power the equipment connect 2 x 1.5 V DC batteries (LR6, type AA). The lower cover on the rear of the equipment has to be removed and the batteries inserted into the correct slot (check the polarity).

**NOTE:** *Whilst doing this, the equipment has to be disconnected from the power supply.*

2. Attach the voltage terminals to each system phase that is to be measured. *Point 3.2 Connection diagrams.*

**NOTE:** *The user must change between single phase mode or three phase mode by giving a short press on the II/III button, depending on the type of installation.*

3. Attach the correct current clamp on phase 3 (balanced three phase) or on phase 1 (single phase).
4. Keep to the connections shown in the diagrams to obtain power readings, P.F. and correct form of energies.

#### **To start up the equipment:**

5. Press the **[ON/OFF]** switch on the front of the analyzer. After starting the **C-80** software version appears on the display.
6. At this point, the **C-80** will detect the clamp connected. This process of self detection is done when a new clamp is connected. (*See point 3 Connection and start-up*).
7. After a few seconds the main system parameters will appear on the display.

When starting measurements in a particular installation the equipment settings have to be checked and if necessary changed (following the instructions in section 4 Programming and displaying parameters). If this is not done, it may mean that the measurements are not correct.

The **C-80** Analyzer has an energy saving system. If no key is touched for 5 minutes, the **C-80** switches itself off. This does not occur if the equipment is recording.

To switch off the equipment, the **[ON/OFF]** button has to be pressed.

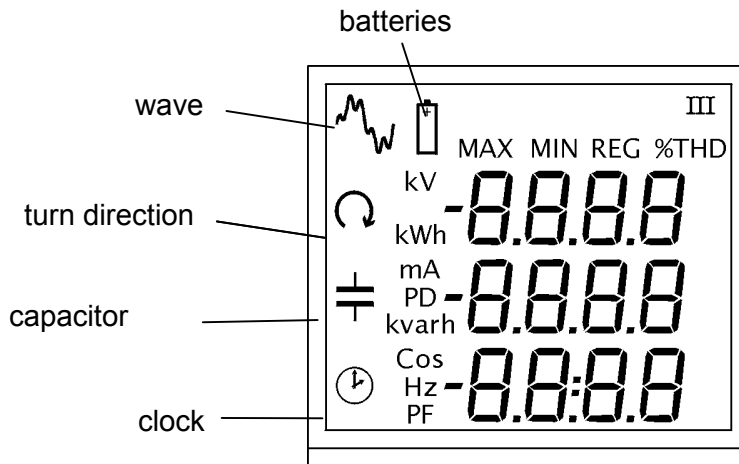

### 3.5.- Presentation of data on the display

On the liquid glass display (LCD) 7 segments of 3 lines and 4 digits per line with indicating icons, the instant, maximum, minimum values can be displayed, along with recorded values and configuration screens.





The display icons have a different meaning depending on the menu being operated. The following tables show all the possible icons that can appear and their meaning. For more information see each specific menu section.



#### Measurement menu:

ICON	MODE	Description
Units	ON	Indicates the variable units displayed
MAX	ON	Shows maximum values
MIN	ON	Shows minimum values
%THD	ON	Indicates the THD screen is showing
REG	NORMAL FLASHING	The equipment is recording
REG	NORMAL FLASHING	Instant registering of the user ( photo )
	NORMAL FLASHING	A THD alarm has tripped. The THD value is above that programmed by the user
II	OFF	Single phase mode
III	ON	Balanced three phase mode
	NORMAL FLASHING	Low battery
	NORMAL FLASHING	Three phase connection error. Indicates that the turning direction is incorrect. Check the connection.



**Setup menu:**

ICON	MODE	Description
Units	ON	Indicates the variable unit that can be edited
Pd	ON	Set up screen for maximum demand variable and period
%THD (V/I)	ON	Set up screen for harmonic distortion alarm
REG	ON	Set up screen for recording period
	ON	Clock setup screen (the date can be edited)
	NORMAL FLASHING	Low battery

**Registering menu:**

ICON	MODE	Description
Units	ON	Indicates the variable unit registered
%THD	ON	THD screen
	ON	Screen showing the date of recording
	NORMAL FLASHING	Low battery
REG	NORMAL FLASHING	Recording advance

**Capacitor use:**

ICON	MODE	Description
	NORMAL FLASHING	Allows reactive power to be edited
Cos	NORMAL FLASHING	Allows the cosine to be edited
	NORMAL FLASHING	Low battery

**CLEAR mode:**

ICON	MODE	Description
	NORMAL FLASHING	Low battery

## 4.- PROGRAMMING AND PARAMETER DISPLAY

### 4.1.- Basic setting diagram

To set the **C-80** and to display the parameters required by the user in an easy and intuitive way, the **C-80** is divided into a series of display and setting menus selected via the keypad. (See point 3.3 Functions of the keyboard).

After having started the **C-80**, the first screen that appears is for the Measurement menu. Using this menu, via a long or short press, the different menus and modes can be selected.

The diagram below shows all of the menus and modes that can be accessed from the measurement menu.

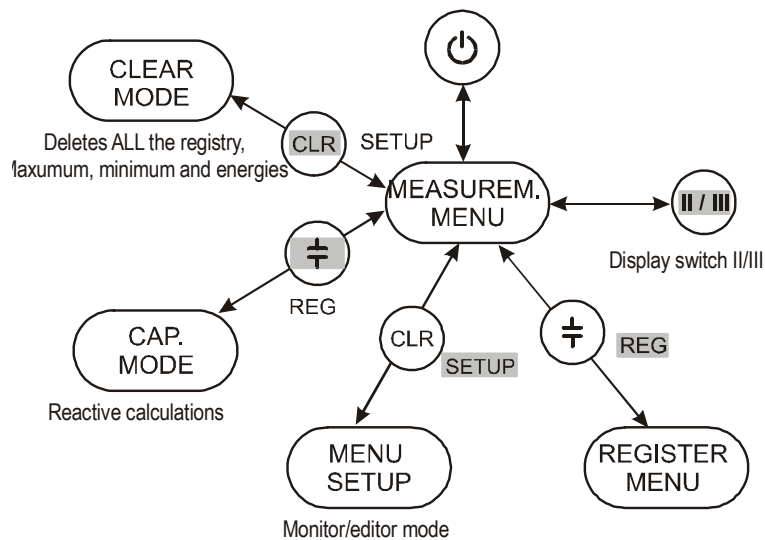

**NOTE:** The keys that have to be pressed to access the required mode are highlighted.

#### Short press:

- **[H]** Access to Reactive power mode calculation.
- **[CLEAR]** Access to CLEAR use (Delete recordings, maximums, minimums and energies).
- **[ENTER]** Starts recording.

#### Long press:

- **[REG]** Access to registering menu (Displays recordings made).
- **[SETUP]** Access to SETUP mode (Configuration of the **C-80**).

#### 4.2.- Measurement menu

This menu allows the measured parameters to be displayed in real time by the **C-80**. This menu only displays the parameters and nothing may be set nor edited.

Using the [**▼**] and [**▲**] keys, we can move between the different screens displaying the instant values. If the same keys are pressed for a long time, the maximum and minimum values parameters will be displayed for a few seconds.

Measurement menu	
Screen No.	Parameters displayed
1	<p><b>Voltage (V, kV):</b> Displays the average instant values of the three phases (III), or of 1 phase and neutral (II).</p> <p><b>Current (mA, A, kA):</b> Displays the value measured in L3 (III) or in L1 (II).</p> <p><b>Frequency (Hz):</b> Displays the instant value of the frequency.</p>
2	<p>From the instant data on voltage VL1-L2 and current L3 in three phase mode or VL1-VL2/N and L1 current in single phase mode the total instant power consumed is calculated:</p> <p><b>Active Power consumed (W, kW).</b></p> <p><b>Inductive and capacitive reactive power consumed (Var, kVAR).</b></p> <p><b>Power Factor (PF):</b> Displays the average three phase value.</p>
3	<b>Active energy consumed (Wh, kWh):</b> Value of Active energy meters.
4	<b>Inductive reactive energy consumed (VarhL, kVARhL):</b> Value of inductive reactive energy meters (L).
5	<b>Reactive capacitive energy consumed (VarhC, kVARhC):</b> Value of capacitive reactive energy meters (C).
6	<b>% THD (V/I):</b> % of Harmonic Decomposition with respect to the voltage and current fundamental.
7	<p><b>Power demand:</b></p> <p>To calculate power demand the <b>C-80</b> uses a rolling display system.</p> <p>This system keeps the averaged current value for the interval being accumulated.</p>

**NOTE:** For the meaning of the icons please see section 3.5 Presentation of data on the Display.

**NOTE:** It is only possible to see the MAX and MIN values on screens 1, 2, 6 and 7.

Measurement menu diagram:

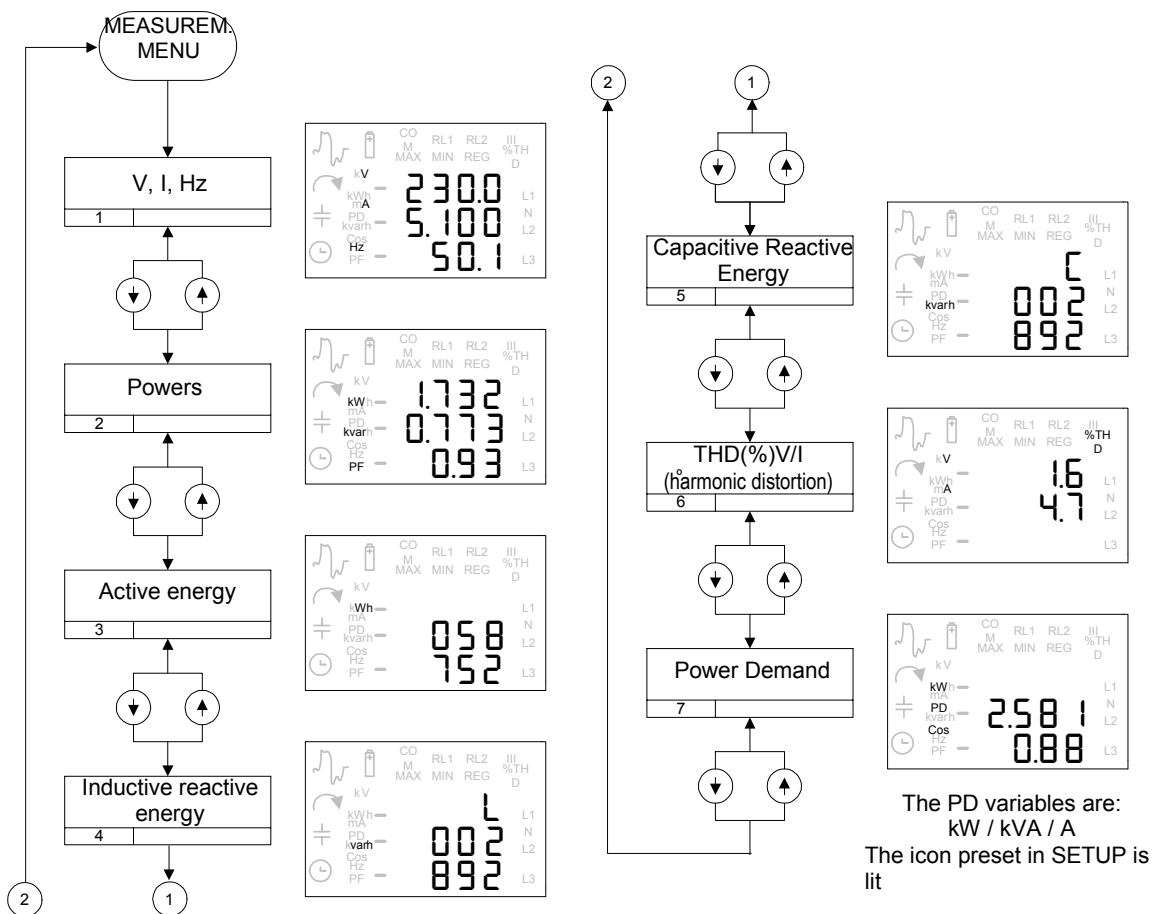

The following table shows the limits of the measured values

Variable	Maximum	Minimum
Voltage	550.0 V	70V
Current	20000 A	20 mA
Frequency	65.0 Hz	45.0 Hz
Active Power	9999 kW	W
Reactive power	9999 kvar	-9999 kvar
PF	1.00	-1.00
Active energy	9999999999 wh	
Reactive energy L/C	9999999999 varh	
%THD V/I	999.9%	0.0%
PD	kVA	9999 kVA
	kW	9999 kW
	A	9999 A
Cosφ	1.00	0

### 4.3.- SETUP menu

To access the SETUP menu press for a long time the **[SETUP]** key, from the Measurement menu. The screen will show **[Set In]**.

To exit the SETUP menu press for a long time the **[SETUP]** key. The screen will show **[Set Out]**. Return to the measurement screen from which it was accessed.

When the equipment enters the SETUP menu it stops registering if it were so doing. On returning to the measurement menu the action does NOT start again until it is “triggered” by the **[ENTER]** key.

Once in the SETUP menu, the configuration of the parameters can be changed and edited.

There is a difference in the SETUP menu between two operating modes:

- **Monitor mode:** Allows the configuration parameters to be displayed
- **Edit mode:** Allows the configuration parameters to be displayed.

To do this the following keys are used:

#### ENTER key:

The **[ENTER]** key switches between monitor mode (displays the configuration) and edit mode (Parameter configuration).

Pressing the **[ENTER]** key allows the parameters on the current screen to be edited using the cursor keys. Once the parameter configuration has been completed press the **[ENTER]** key again to exit edit mode.

#### CURSOR keys:

In monitor mode the **[▼]**, **[▲]** and **[▶]** keys allows the 8 screens in the Setup menu to be browsed.

In edit mode the **[▼]**, **[▲]** keys increase the value of the digit being edited and the **[▶]** key moves the digit to be edited one place to the right. In edit mode the **[▼]**, **[▲]** keys can remain pressed to quickly increase/decrease the digit.

The following table shows the limit of the configurable values:

variable	Display	maximum	minimum
Current primary	CP	20000	1
Frequency	Set Freq	65	45
Power demand variable	PD Code		
PD recording time	PD per	60	1
THD alarm Voltage	Alar THDU	999.9	0.0
Current THD alarm	Alar THDA	999.9	0.0
Registering time (memory)	Treg	90	0*

\*Indicates not registering

The following diagram shows the intuitive way all the SETUP screens can be configured.



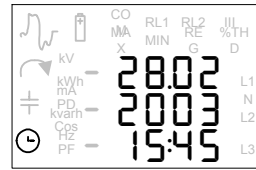
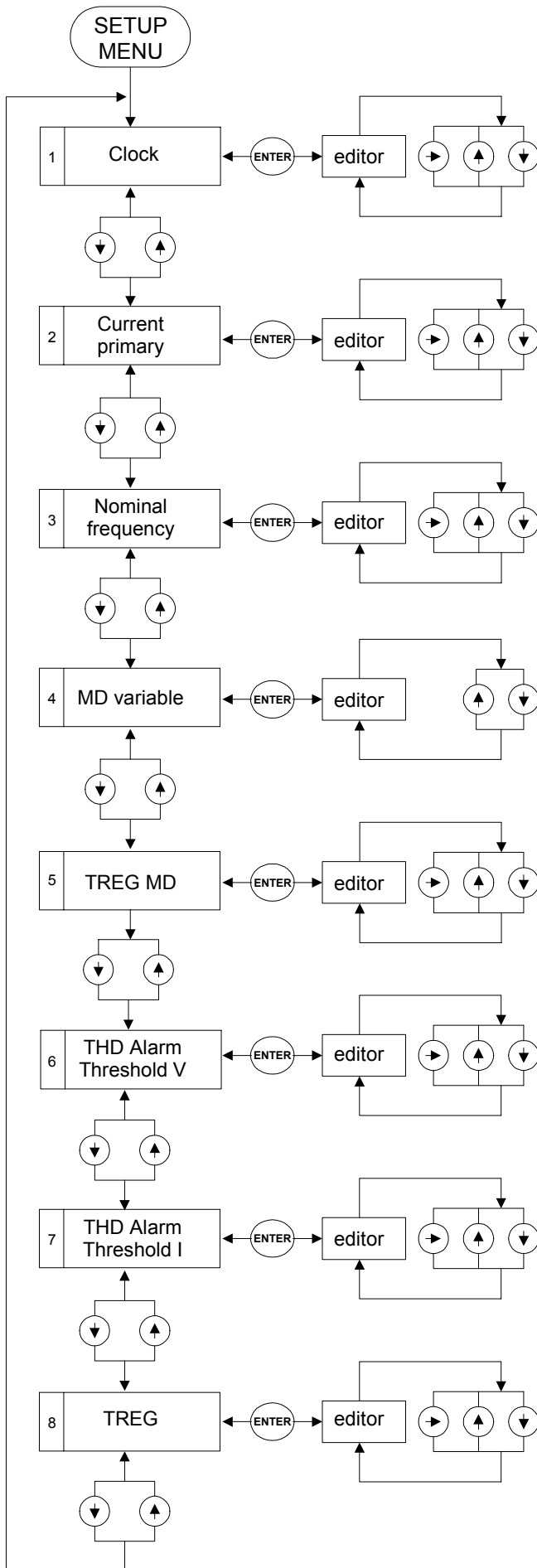

**Screen 1**  
Allows the editing of date:  
Day. Month  
Year  
Time

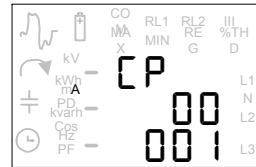

**Screen 2**  
Configuration of the transformation ratio of the current primary.  
Range from 1-20000

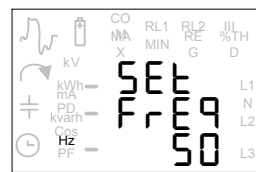

**Screen 3**  
Configuration of the Nominal frequency used in the system.

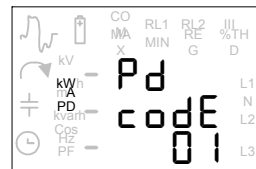

**Screen**  
Power demand:  
Pd 01-Apparent power (kVA)  
Pd 02-Active power (kW)  
Pd 03-Current (A)

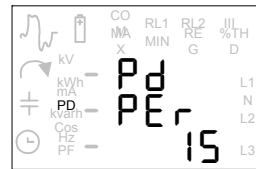

**Screen 5**  
Power demand registering period.  
From 1 to 60 minutes.

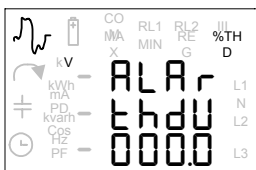

**Screens 6 and 7**  
The threshold is configured at which the voltage/current harmonic distortion alarm is triggered.

On triggering the alarm, the wave icon will flash on the measurement menu

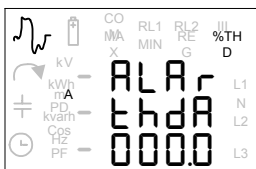

**Screen 8**  
Time of recording.  
Each register stores the average data measured during the preset time (0-90 min.)

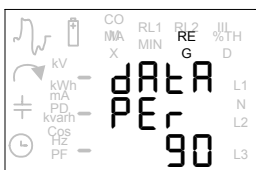

### 4.4.- Capacitor mode

To access capacitor mode, press once the [H] key from the Measurement menu. To exit, press the [H] key again and return to the measurement menu.

The capacitor use only operates if the equipment is connected to a three phase system with inductive load. Here it measures a > 0 reactive power. If not on accessing capacitor mode, it will show an error message.

To edit the values the following keys are used:

**ENTER key:**

Pressing the [ENTER] key allows the user to switch between the two calculation modes.

**CURSOR keys:**

The [▼] and [▲] keys increase the value of the edited digit and the [▶] key moves the cursor one place to the right. The [▼], [▲] keys may be pressed continuously to quickly increase/decrease the digit.

Capacitor mode allows two forms of calculation:

- a. Introduce power in kVAR:

On introducing the power value the **C-80** calculates the resulting Cosφ.

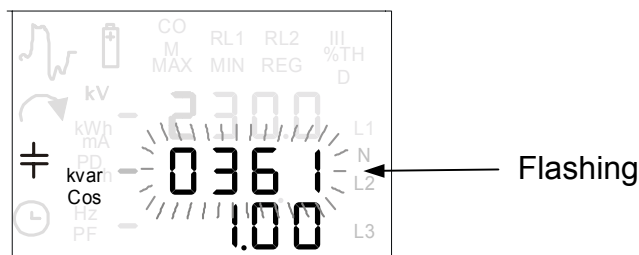

- b. Introduce power in Cosφ kVAR:

On introducing the required value of Cosφ the **C-80** calculates the power in kVAR in order to do the correction.

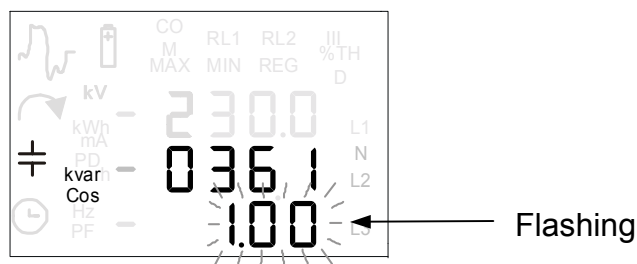

When the equipment is in capacitor use it stops recording if so doing). On returning to the measurement menu it does NOT start recording again until it is "tripped" by the **ENTER** key.

**NOTE:** To do this calculation the C-80 must be measuring.

#### 4.5.- CLEAR mode

To access CLEAR mode, press once the **[CLEAR]** key from the Measurement menu. To exit, press the **[CLEAR]** key again and return to the measurement menu. On exiting the action is entered and it returns to the measurement menu.

Clear mode allows the deletion of:

- the whole recording
- the energies
- the maximums and minimums

When the equipment is in Clear mode it stops recording (if so doing) and on returning to the measurement menu, it does NOT start recording again until it is "tripped" by the **[ENTER]** key.

When the equipment is in Clear mode the following screen is shown, where the word "NO" is FLASHING NORMALLY.



To clear:

#### **CURSOR keys:**

By pressing the CURSORS **[▼]** and **[▲]** the user can switch between NO / YES.

#### **CLEAR key**

If recordings, energies and maximums and minimums are to be deleted select the word YES, then to enter the action press the **[CLEAR]** key and return to the measurement menu.

#### 4.6.- Registering menu

The registering menu shows screens identical to those in the measurement menu with the exception that there is a start screen showing date and time of registering.

When the equipment enters the registering menu it stops registering, if it is so doing. On returning to the measurement menu, the registering is NOT restarted until it is "tripped" by the **[ENTER]** key.

If no register has been made or all registers have been deleted from the memory, on entering the registering menu, the words <NO File> appear on the screen. (*To register, see points 4.6.1 and 4.6.2.*)

To access the Registering menu press the **[REG]** key for a while from the Measurement menu. The screen will show **[Reg In]** (with recording in the memory).

To exit the SETUP menu press once again the **[SETUP]** key for a while. The screen will show **[Reg Out]**. Return to the measurement screen from which it was accessed.

Once in the registering menu, the following keys are used:

**REG key:**

Exit the register menu and return to the measurement menu. Return to the measurement screen from which it was accessed.

**ENTER key:**

Pressing the enter key allows the registering to be advanced. This is shown by the RAPID FLASHING of the REG icon. The first screen is the clock and by repeatedly pressing the **[ENTER]** key the required register is displayed.

**CURSOR keys:**

In monitor mode, the **[▼]** and **[▲]** keys allow the 8 registering screens to be browsed.

**MAX-MIN keys:**

With the MAX/MIN keys the maximum and minimum values of the variables are shown for 3 seconds.

When no maximum and minimum are displayed this is shown by BLANK SPACES

The **C-80** ANALYZER has the option to record the measurements and store them in a non-volatile rotating memory with a capacity of up to 33 recordings. The **C-80** has an option to register up to 33 measurements and store them in the non-volatile rotating memory. It has a rotating file, meaning that once the 33 recordings are full it will continue registering new data in the oldest position.

The registers may be done automatically and timed or can be done instantaneously by pressing the **[ENTER]**. The two methods can be simultaneous.

#### 4.6.1.- Timed registers

In setup (See point 4.3 Setup) the registering time period can be set from 1 to 90 minutes (If 0 minutes is entered, timed registers are not done.)

Once the time has been entered, **[ENTER]** has to be pressed to start the timed registering. This starts the register and is shown by REG flashing on the screen.

Registering is stopped when the equipment is switched off or any menu is entered. Registering may be restarted at the point where it was stopped by pressing **[ENTER]** again.

During the time between registers (recording period) the instantaneous variables are stored and averaged to calculate the maximum and minimum during this period. Once the timed period is over the averages and the variables are calculated. The maximum and minimum energy values are logged, recorded in the memory and all the variables are started

The register is synchronised with the equipment's clock and, where possible, registers in multiples of one hour. That is to say, if 15 minutes registering period is set, it registers on the quarter hour or at 15, 30 and 45 minutes past the hour.

Example: If the register is started at 11:09, the first register will be at 11:15 with a 6 minute record and from then on it will be each 15 minutes.

#### 4.6.2.- Instant registering

THE **C-80** ANALYZER allows instant registers of the measurements, i.e. taking a "photo" of the present measurements. The values registered will be those measured instantaneously. The variables will be the same as the timed registers except that the maximums and minimums will be those on the display and not those from a preset period.

To register these, the **[ENTER]** key has to be pressed on any measurement screen. The display will flash REG.

By pressing the **[ENTER]** key once, a timed register is taken. Pressing it again an instant register is taken.

This form of registering is totally compatible with the previous registering, i.e. a timed register can be done but the **[ENTER]** key may be pressed at any time to register instantaneously.

	First press of <b>[ENTER]</b> key	2 <sup>nd</sup> and successive pressing of <b>[ENTER]</b>
Recording	For time	Instant

Example:

With a recording period of 15 minutes and pressing **[ENTER]** ⇒ each 15 minutes a recording is made.

Pressing again **[ENTER]** ⇒ a recording will be made of that moment when enter was pressed, apart from the other recordings.

**Recording of variables:**

The 21 measurement variables recorded are:

Variable	Description
V12	Average instantaneous voltage
IL3	Average instantaneous current
kW	Average instantaneous active power
kvar	Average instantaneous reactive power
Hz	Average instantaneous frequency
PF	Power factor of the averaged measurements
COS $\phi$	Cos $\phi$ of the averaged powers
THDV	% harmonic distortion of the averaged V
THDI	% harmonic distortion of the averaged I
kWh	Value of Active energy
kVARhL	Value of inductive energy
kVARhC	Value of capacitive energy
V12_MAX	Maximum value of V12
IL3_MAX	Maximum value of IL3
kW_MAX	Maximum value of kW
kVAR_MAX	Maximum value of kVAR
Hz_MAX	Maximum value of Hz
PF_MAX	Maximum value of PF
COSFI_MAX	Maximum value of cos $\phi$
V12_MIN	Minimum value of V12
Hz_MIN	Minimum value of Hz

Particulars:

**kvar:** Reactive power can be inductive or capacitive, but an average cannot be made of the two together. The recording variable is the higher average value between inductive and capacitive.

**PF and COS  $\phi$ :** Variables are calculated from the averages of the other variables, i.e. it gives the PF and COS  $\phi$  of the averaged variables. To indicate whether it is capacitive reactive the sign is negative. If there is inductive reactive power the sign is positive.

**THD:** The recorded THD is not an average of the %THD measurements, as it would not offer any useful information, rather it is the percentage of the average of the harmonics.

**4.7.- Additional current leakage screen**

To the portable **C-80** there can be connected a clamp to detect leakages in the system. The operation of the **C-80** on connecting a CPF (leakage clamp) is different to that when connecting other types of clamp.

Connecting a CPF-5 (leakage clamp) to the C-80, the equipment has the following configuration:

**Measurement menu:**

Only the current value is shown and the frequency value preset in the setup.

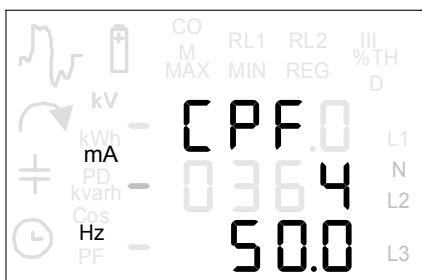

**Setup menu:**

On accessing the setup menu the following screens can be configured (see section 4.3):

Screen	Function
1	Clock (edit date)
2	Current primary
3	Nominal frequency
8	Period of recording

**Registering menu:**

Timed and instant registers can be taken (see section 4.6).

In the registering menu the time of the register and the current value and the frequency will be displayed.

Up to 33 recordings can be made.

## 5.- TECHNICAL FEATURES:

Measured line voltage margin	70-500 V AC.
Voltage overrange	10% (550 V AC.)
Accuracy voltage measurement	0.5% ± 2 digits
Measured current margin	2 Vrms (depending on clamp)
Current overrange	10%
Accuracy current measurements	0.5% ± 2 digits
Measured frequency margin (VL12)	45 – 65Hz
Accuracy power measurements	1% ± 2 digits
Accepted clamps	CP2000/200, CP1000, CP500, CP100, CP5, CPF-5 CFLEX (auto-detectable ranges 20000, 2000, 200)
Power supply	2 x 1.5 V DC. (LR6 type AA batteries)
Operating period	200 hours
Keypad	1 ON/OFF + 7 function keys
Display	7 segments, 3 lines x 4 digits, + indicating icons
Voltage terminals	L1, L2/N, L3
Current clamp terminals	4 wire (signal ID -> automatic detection)
Recording	Circular file (between 1 min. and 90 min.)
Weight:	303.4 g.
Measurements	172x100x50 mm
Other features	Power demand, harmonic distortion alarm (THD), clock

### Standards:

#### Emission

- IEC 61000-6-3:1996, Domestic environments and light industry emissions.
  - CISPR 11:1997 MOD, Radiated (CISPR 22:1997 MOD-Class A).
- IEC 61000-6-4:1997, Industrial emissions.
  - CISPR 11:1997 MOD, Radiated (CISPR 22:1997 MOD-Class A).

#### Immunity

- IEC 61000-6-2:1999, Industrial immunity.
  - IEC 61000-4-2:1995, ESD.
  - IEC 61000-4-3:2002, EM Radiated field of RF.
  - IEC 61000-4-4:1995, EFT burst.
  - IEC 61000-4-5:1995, Surges
  - IEC 61000-4-6:1996, RF common mode.
  - IEC 61000-4-8:1993, 50 Hz H-field.
- IEC 61000-6-1:1997, Domestic environments and light industry emissions.
  - IEC 61000-4-5:1995, Surges

#### Safety

- IEC 61010-6-1:2001, electric safety



## **6.- FREQUENTLY ASKED QUESTIONS**

### **The equipment does not measure correctly**

Ensure that the equipment is in correct mode (single phase / three phase) according to the type of installation and that the equipment is correctly connected.

### **In which phase must the current be measured operating in balanced three phase mode?**

In phase 3.

### **Why is L2/N written on the second connector?**

Because when measuring a three phase system L1, L2 and L3 are connected, whereas for single phase measurements L1 is connected and L2 will be neutral.

### **If the equipment has self detection of clamps why does it have a transformation ratio?**

For hen measuring in the secondary via a current transformer is required.

### **Why does it stop measuring other parameters when it measures leakages?**

Because there is no point in giving the other parameters, because it is not measuring current in one of the phases, it is only measuring differential current.

### **Can rechargeable batteries be used?**

Yes, if they are those detailed in the instruction manual.

### **The equipment does not work and there is nothing on the display**

If there is nothing on the display, it may be due to weak batteries. If it does not work after replacing the batteries, contact our technical service.

### **Can measurements be taken from unbalanced three phase systems?**

Yes, it can measure each phase separately in single phase mode.

### **Can the voltage transformation ratio be set?**

No, it cannot operate via voltage transformers.

### **Why, when exiting any menu the equipment stops registering?**

Because entering any menu can change the configuration of the equipment. On exiting the menu ENTER has to be pressed to restart registering. There would also be measurements taken under different conditions in a same recording.

### **Why does the equipment switch itself off after 5 minutes?**

Because the equipment has gone into energy saving mode. If this is not required, the equipment must be registering.

## **7.- MAINTENANCE**

The C-80 does not require any special maintenance. Any adjustment, maintenance or repair to the open equipment is to be avoided. If it cannot be avoided it must be undertaken by someone qualified and well informed of the necessary action.

When any operational or protection fault is suspected the equipment must be withdrawn from service and any accidental connection must be avoided. The equipment is designed to be changed quickly in the event of any breakdown.

## **8.- TECHNICAL SERVICE**

In the event of any equipment failure or any operational queries please contact the technical service of CIRCUTOR S.A.

*CIRCUTOR S.A. - After sales service*

*Vial Sant Jordi, s/n*

*08232 - Viladecavalls*

*tel - (+34 ) 93-745 29 00*

*fax - (+34) 93-745 29 14*

*E\_Mail: [central@circutor.es](mailto:central@circutor.es)*